



PRODUCT CATALOG



WORLDWIDE INTEGRATOR

NEMI presents manufacturing solutions for the metal, wood, plastic composites, and stone industries with a powerful combination of vacuum workholding products and new, automated, vacuum workholding systems. These systems include a full line of modular components for holding, positioning and repositioning unfinished wood, stone or metal parts in the automated CNC production of doors, cabinets, stone products, aerospace components, and similar metal, wood and plastic products.

Included in the vacuum line of workholding is the patented NEMI modular grid system. It is designed to work in conjunction with a variety of single to multi-spindle setups for high volume part production assuring precision and repeatable accuracy.

NEMI modular vacuum workholding setups can be easily configured to handle any design and dimension on the grid system table setup. Utilizing a variety of positioning pods, chucks and locating pins, these setups have the advantages of a dedicated fixture system. Tables range in size up to 7'x 12', and can be made to customer specifications.

These grid tables form the mounting platform for a flexible workholding system. Ideal for use on CNC machines for reconfiguring the components to handle various size parts and for use on other jobs. NEMI workholding systems provide a rapid cost payback by reducing labor content and increasing productivity.

THE NEMI DIFFERENCE



NEMI strives to manufacture the highest quality, most user friendly products for CNC machines. NEMI has been manufacturing digitizers, tool setters, vacuum pods, vacuum tables, vacuum fixtures and software for over 20 years.

Our commitment to quality products has helped our users continually out-perform their old systems. We take pride in our products made here in Minnesota and will continue to add new products based on our customer needs for increased production.

- Patented Grid Table design
- Patented Slider Pod design
- Highest table flow rate
- Versatile, modular fixturing
- Fast setup times
- Fixtures for 3, 4, and 5-axis machining centers
- Over 80 years combined experience
- Economical solutions for short run and production runs.
- Solutions for wood, stone, glass, metal, plastics, composites and more.

CUSTOMIZABLE PRODUCT OPTIONS

NEMI's extensive experience in the CNC Machining industry allows us to offer fully customized solutions.

TABLE OF CONTENTS

OVERVIEW

About Vacuum Fixtures.....	4
Ordering Information.....	5
Terms & Conditions.....	6

VACUUM WORKHOLDING PRODUCTS

Grid Tables & Chucks

Vacuum Grid Table.....	8
Vacuum Plenum Table.....	8
Vacuum Tombstone.....	8
Portable Vacuum Grid Chuck System.....	9
Low Profile Chuck System.....	10
Vacuum Chuck Packages.....	10
Vacuum Grid Table.....	11
Round Vacuum Chucks.....	11
Mini Vacuum Chucks.....	12
Lathe Chuck Jaws.....	12

Vacuum Pods

How Slider Pods & Grid Tables Work.....	13
Vacuum Pods Sizes.....	14

Slider Pods

Square Vacuum Slider Pods.....	14
Straight Vacuum Slider Pods.....	15
Round Vacuum Slider Pods.....	16
Corner Vacuum Slider Pods.....	16
Curved Vacuum Slider Pods.....	17
Dual Zone Vacuum Slider Pods.....	17
Blank Top Slider Pods.....	17

Roto Vacuum Pods.....

	18
--	----

One Piece

One Piece Vacuum Pods.....	18
Straight One Piece Vacuum Pods.....	19
Corner One Piece Pods.....	20
Round Vacuum Pods.....	21
Round One Piece Vacuum Pods.....	21
Low Profile Vacuum Pods.....	22
Extra Long One Piece Pod Series.....	23

Risers Plates.....

	23-24
--	-------

Modular Stackable Pods.....

	25
--	----

T-Shape Pods.....

	26
--	----

Face Frame Pods.....

	26
--	----

5 Axis Fixturing

Convex/Concave Vacuum Pods.....	27
5 Axis Stackable Vacuum Pods.....	27

Clamps

Vacuum Mushroom Clamp.....	28
Dual Zone Vacuum Slider	
Pod w/ Fence.....	28
Mushroom Clamp Spacers.....	28
Vacuum Mushroom Clamp Kit.....	29

Vises

Mechanical Vises.....	29
Vise Plate Vacuum Pod Base.....	29
Vacuum Tube Vise.....	30
Modular Grid Vise.....	30
Multi Part Vise.....	30
6" Vacuum Vise.....	31
Slider Vises.....	31

Location Devices

Part Locator Pins Modular.....	32
Fixed Locator Plate.....	32
Pinch Block.....	32
Grid Work Stop.....	33
Grid Locator Plug.....	33
SCM Grid Locator Plug.....	33

Pod & Rail

Homag/Weeke Pod & Rail Slider Pods... ..	34
Homag/Weeke One Piece Pod &	
Rail Vacuum Pods.....	35
Homag/Weeke Slider Vises.....	36
Weeke Vantech Vacuum Pods.....	36

Point to Point

Biesse Vacuum Pod Top & Base.....	37
-----------------------------------	----

Locator Pin Pod.....

	38
--	----

Vacuum Fixturing

Vacuum Slider Pod w/ Fence –	
One Side or two.....	39
Vacuum Pod w/ Roller.....	39
Mini Hole Rubber Grip Pod.....	39

Tooling & Accessories

Grid Covers.....	40
Grid Vacuum Gage.....	40
Grid Seal Plug.....	40
SMC Routhtech Grid Plugs.....	40
Vacuum Grid Table Auto Valve.....	41
Vacuum Pod Spike Inserts.....	41
Vacuum Rotary Unions.....	41
Vacuum Pod Hose.....	42
Vacuum Fittings.....	42
Vacuum Interface Kits.....	43

In Line Vacuum Filters.....	43
Vacuum Pod Setter.....	43
Integration Kits.....	44
Auto Vacuum Shut Off Valve.....	44
Vacuum Pressure Switch.....	44
Tool Tightening Block.....	45
Collet Torque Wrench.....	45
Spindle Socket Cleaning Tool.....	45
Nemicom (PC to CNC Software).....	45

Vacuum Pumps//Accumulator Systems

Coolant Trap/Filter.....	46
Standard Vacuum Pumps.....	46
Claw Vacuum Pumps.....	46
Vacuum Accumulator Systems.....	47
Vacuum Generators.....	47

Tool Setters

Tool Setter.....	48
Tool Setter Pivot Arm.....	49
Counter Sink Gauge.....	49
Tool Setting Gauge.....	49

Gasketing

Closed Cell Gasketing.....	50–51
----------------------------	-------

FLAT PLATE FIXTURING

Square Vacuum Pods.....	52
Round Vacuum Pods.....	52
Rectangular Vacuum Pods.....	53
Sink Support Pods.....	53
Corner Radius Pods.....	54
Mechanical Vacuum Support Clamp.....	54
Vacuum Pod Fence.....	55
Vacuum Pin Stop.....	55
Portable Vacuum Manifolds.....	55
Strap Clamps for T-Slot	
Table Machines.....	56
Flat Table Vacuum Package.....	56
Flat Table Vacuum One Piece Pod.....	56
Flat Table Locator Pin Pod.....	57
Flat Plate Vacuum Pod Base.....	57
Low Profile Vacuum Pods.....	57
Bench Vacuum Pods.....	57

DIGICODER DIGITIZER & SOFTWARE

Rapid Capture Geometry.....	58
Setting Up For Digitizing.....	58
Rapid Capture With 2 Axis Digitizer.....	59
Digitizer Software.....	59
Digitize Computer Upgrade Kit.....	59

CONTACT US

Visit our website at: www.NEMI.com, Call us at: (763)-856-2044, or Email us at: Office@NEMI.com

ABOUT VACUUM & CUSTOM FIXTURES

A FEW WORDS ABOUT VACUUM

The basic science of vacuum clamping involves the atmosphere. Essentially all atmosphere from beneath the workpiece is removed. The atmosphere above and around the workpiece is what actually holds the material in place.

At sea level, the atmosphere provides 14.7 PSI of hold down force. However, for every 1,000 feet of elevation you will lose approximately .49 psi of hold down force.

For example, a workpiece held down by a 12" x 12" square area would effectively have 2,116.8 LBS of hold down force at sea level. Vacuum is measured in inches of mercury (hg). A perfect vacuum is 30 inches of mercury (30hg) but the maximum we can draw at sea level is 29.92 hg under perfect conditions.

See table for some examples.

Altitude (ft)	Atmospheric Pressure (psi)	Max Vacuum (in/hg)
0	14.7	29.92
1000	14.16	28.86
2000	13.66	27.82
3000	13.16	26.82
4000	12.68	25.84
5000	12.22	24.89
6000	11.77	23.98
7000	11.33	23.09
8000	10.91	22.22
9000	10.50	21.38
10000	10.10	20.57
11000	9.71	19.79
12000	9.34	19.02
13000	8.97	18.29
14000	8.62	17.57
15000	8.28	16.88

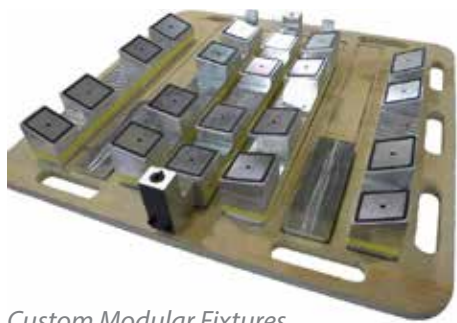

Custom Modular Fixtures.

CUSTOM VACUUM FIXTURES

We have over 30 years of experience manufacturing and designing custom fixtures. Call today for a quote!

We can work with you to build from your drawings or design a complete solution. Call us for all your custom vacuum workholding needs.

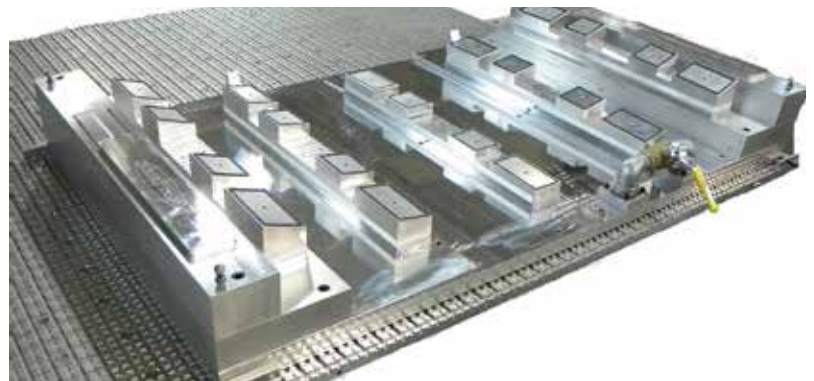

ORDERING

- Phone Toll-Free 888-625-5367 or (763-856-2044).
- Monday through Friday 8:00 a.m. to 4:30 p.m. Central time zone.
- Fax your Purchase Order to 763-856-3378, 24 hours a day.
- Email your purchase order to office@nemi.com.

INTERNATIONAL SHIPPING OUTSIDE U.S.

- We ship worldwide.
- Product prices and delivery may change when shipping outside the U.S.
- Purchaser is responsible for paying any duties and taxes.

SHIPPING

- We ship UPS, United Postal Service and many national trucking companies.
- Our shipping department will ensure your order is transported in the most economical manner possible

RUSH ORDERS

- Your order can be shipped Next day or Second day.
- Orders requesting Rush Shipping may have an additional cost.

PAYMENT

- Payment by Check - Make checks payable to: Northern Engineering & Mfg. Inc.
- C.O.D.
- Major Credit Cards accepted: VISA, AMERICAN EXPRESS, MASTERCARD, and DISCOVER
- Open Account– Request a credit application by emailing Office@NEMI.com

TERMS & CONDITIONS

- By placing an order and not stating otherwise, buyer has read and agreed to all Terms & Conditions set forth by Northern Engineering & Mfg. Inc.
- See pages 6–7 for Terms & Conditions.
- We make every effort to maintain our pricing, however, due to market fluctuations, prices are subject to change without prior notice.

TERMS AND CONDITIONS

ENTIRE AGREEMENT

We acknowledge receipt of your order and agree to ship the products you have ordered as listed on the order form. This agreement shall constitute the entire agreement between you and Northern Engineering and Manufacturing, Inc. ("NEMI"). You may not alter the terms of this Agreement. Acceptance of this offer shall be on its exact terms. In the event you fail to execute this Agreement and we satisfy your order by shipping requested product to you, your acceptance of the products delivered shall constitute acceptance of the offer contained herein, in its exact terms.

SECURITY AGREEMENT

When accepted, this document is a Security Agreement under the Uniform Commercial Code ("Code") and we retain and you grant to us a Purchase Money Security Interest in the Products as security for payment of the purchase price hereunder and upon your default we shall have the rights and remedies of a Secured Party under the Code filing documents and you irrevocably authorize us to sign such document on your behalf. The forgoing is without prejudice to our rights under Article 2 and/or Article 9 of the Code.

PRODUCT USE

Product sold in accordance with this Agreement is to be used in accordance with applicable federal, state and local law and the manufacturer's recommendations. Because NEMI has no knowledge of local or state regulations that do not apply to Zimmerman, MN it makes no representations regarding the product's compliance with those state or local regulations. To assure that product use is consistent with law and manufacturer's recommendations, you are responsible for reviewing product application manuals and state, local and federal law that might affect the use of the product. NEMI makes no guarantee that the product complies with local, national or state regulations. In the event the product is altered, misused, improperly maintained, improperly installed or used in any manner inconsistent with NEMI's recommendations, NEMI shall not be responsible for injury or damage that results.

WARRANTIES

NEMI warrants that the product is free from defects in workmanship and materials for (45) days from date of shipment. Misuse, negligence, accident, improper installation, improper maintenance, alteration or repair by personnel other than those employed by NEMI or someone authorized by NEMI to repair the product shall constitute a Waiver of the warranty against defects in workmanship and materials. THIS WARRANTY AGAINST DEFECTS IN WORKMANSHIP AND MATERIALS ARE EXCLUSIVE AND IN LIEU OF ALL OTHER WARRANTIES. NEMI MAKES NO OTHER WARRANTIES, EXPRESS OR IMPLIED AND HEREBY DISCLAIMS ALL IMPLIED WARRANTIES INCLUDING WARRANTIES OF MERCHANTABILITY AND FITNESS FOR A PARTICULAR PURPOSE. There are no warranties which extend beyond the description hereof.

DELIVERY DAMAGE

You agree to carefully, diligently and thoroughly inspect the product for damage, defect or shortage immediately upon delivery and to note discovered problems on the freight bill. It is your responsibility to notify the carrier of any damage to the shipping crate or product and to request an inspection report. You shall make claims for Damage resulting from shipping to the carrier and it is your responsibility to maintain packing and shipping materials until your claim is settled. NEMI is not responsible for damage to product resulting from shipping and in no event shall NEMI be required to accept a return of product found unacceptable as a result of damage resulting from shipping.

DEFECTIVE PRODUCT

In the event product is defective in materials or workmanship and you make a timely and appropriate claim, NEMI may, at its option, remove the defect and provide a defect free product or credit your account for costs earlier incurred by you for the defective product.

TERMS

All shipments are subject to this Agreement and the Order Form. Payment shall be made prior to shipment unless alternative arrangements are made with NEMI. Prices are exclusive of any taxes (unless otherwise indicated). In the event you fail to make full payment when due, NEMI may cause all of your obligations to it to be immediately due. Costs incurred by NEMI as a result of your failure to comply with the terms and you shall pay conditions of this Agreement, including reasonable attorneys fees.

TAXES

You agree to pay all applicable Federal, State, or local Manufacturer's or sales, use or value added taxes, or any other tax now or hereafter levied upon this instrument or upon any Products sold on any shipments made hereunder.

CANCELLATIONS

After this offer is accepted, NEMI will incur substantial costs in an attempt to provide you with ordered product and as a result, orders may not be canceled unless you agree to compensate NEMI for losses it will incur (including reasonable profits) as a result of the cancellation.

COPYRIGHTS

The Company reserves the copyright of all drawings, plans and other data provide and reproduction in part or whole is not permitted without permission.

APPLICABLE LAW

Minnesota Law shall govern disagreements arising hereunder and civil disputes arising shall be venue in state court in Sherburne County, Minnesota.

RETURNS

All returns require an RMA number provided by NEMI and are subject to a restocking fee. No returns accepted beyond 30 days of receipt date. Any returns received that do not meet the above criteria WILL BE REJECTED. Returns accepted at NEMI's sole discretion.

VACUUM WORKHOLDING PRODUCTS

GRID TABLES & CHUCKS

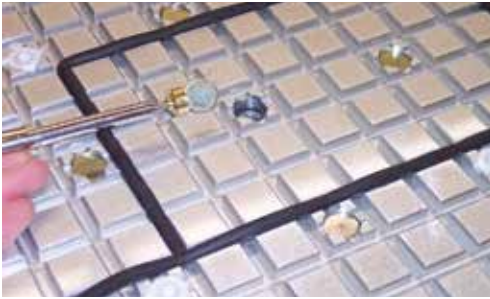

NOTE: Grid Tables with less than 2000 Square Inches have an additional charge. Also available in PVC/phenolic.

Special Sizes Available Upon Request.

VACUUM GRID TABLE

The NEMI Grid Table is designed to securely hold parts using vacuum. Simply remove a washer with a magnet, place one of our vacuum pods over the hole, or gasket your area, and you're ready.

Size	Type	Description	P/N-Size
A x B	Alum.	Vacuum Grid Table	693-A x B
3/8" x 6" 24"	Steel	Magnet with handle.	694
3/4"	Buna	Vacuum Seal	725
1 1/16" Dia.	Steel	Vacuum Plug	724
5/16" Round 100'	PVC	5/16 Grid Table Gasket	795



NOTE: Plenums with less than 2000 Square inches have an additional charge.

VACUUM PLENUM TABLE

The NEMI Vacuum Plenum is designed to be used with our grid tables. Plenums are designed for high flow rates. They can also be used as a router table for flow through machining.

Size	Type	Description	P/N-Size
A x B	Alum.	Vacuum Plenum	868-A x B
Kit	Misc.	1 1/2" Integration Kit	1049
1 1/2" NPT	Misc.	Manifold Block	1048



VACUUM TOMBSTONES

Now you can tool up your horizontal machining center with the versatility of the NEMI Vacuum Workholding System. You can machine flat plate materials, add fixture plates, or use vacuum pods. These tombstones are completely compatible with all NEMI Grid fixture tooling. Just add a rotary union (p/n 1591) and you're ready to go! See Page 41 for rotary union.

Base Size (SQ)	Vac Area 1	Vac Area 2	Height	P/N
15-3/4"	11.5" x 17.5"	9.5" x 17.5"	23"	1592

We have everything you need including the technical expertise to get you up and using vacuum workholding in no time!

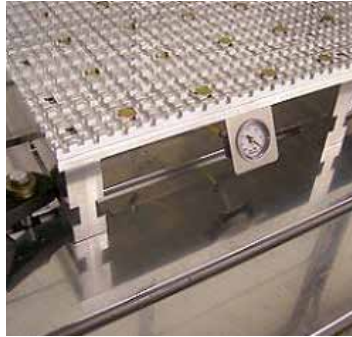

"I think the word AWESOME sums it up. This unit is the difference between the ability to make money on a part or struggle to make parts that run but not very efficiently."

PORTABLE VACUUM GRID CHUCK SYSTEM

The NEMI Vacuum Table is designed to hold parts securely using vacuum. While the vacuum table system doesn't replace a traditional machinist vise, it provides a platform for unique workholding strategies not possible otherwise. Plates are made from cast aluminum plate and precision machined using CNC machines.

These tables are mounted on parallels with the vacuum supply routed up from the bottom. This allows for large vacuum supply inputs not available on smaller vacuum chucks. These units come complete with vacuum port plugs & seals, vacuum gauge, parallels, ball valve, 25ft of vacuum rated hose and all the necessary fittings to have you up and running in no time!

Length	Width	Description	P/N
12"	75"	12 x 75 Portable Vacuum Grid System	1648
12"	29"	12 x 29 Portable Vacuum Grid System	1658
15"	23"	15 x 23 Portable Vacuum Grid System	1670
20"	20"	20 x 20 Portable Vacuum Grid System	1731
20"	30"	20 x 30 Portable Vacuum Grid System	1678
21"	21"	21 x 21 Portable Vacuum Grid System	1675
30"	15"	15 x 30 Portable Vacuum Grid System	1356
24"	16"	16 x 24 Portable Vacuum Grid System	1538
36"	18"	18 x 36 Portable Vacuum Grid System	1378
48"	18"	18 x 48 Portable Vacuum Grid System	1379
40"	20"	20 x 40 Portable Vacuum Grid System	1380
48"	24"	24 x 48 Portable Vacuum Grid System	1381
60"	30"	30 x 60 Portable Vacuum Grid System	1539
40"	40"	40 x 40 Portable Vacuum Grid System	1540
48"	48"	48 x 48 Portable Vacuum Grid System	1541
64"	28"	64 x 28 Portable Vacuum Grid System	1584
50"	20"	50 x 20 Portable Vacuum Grid System	1586
24"	12"	24 x 12 Portable Vacuum Grid System	1587
36"	48"	36 x 48 Portable Vacuum Grid System	1598
40"	60"	40 x 60 Portable Vacuum Grid System	1700

Don't see what you need? Give us a call!

VACUUM WORKHOLDING PRODUCTS

GRID TABLES & CHUCKS



LOW PROFILE CHUCK SYSTEMS

The NEMI Vacuum Table is designed to hold parts securely using vacuum. Similar to a portable vacuum grid chuck, the low profile chuck allows for unique workholding not possible with a machinist vice. These chucks utilize 1" plumbing for maximum flow with the capability of mounting directly to the T-Slot table of your machine. Plates are made from cast aluminum and are precision machined using CNC machines. With this grid plate, setups are fast and simple. These chucks can be made to fit a wide variety of T-Slot tables.

Footprint	Vac Area	Description	P/N
16" x 24"	14.9" x 22"	Table Mount Vacuum Grid System	1699

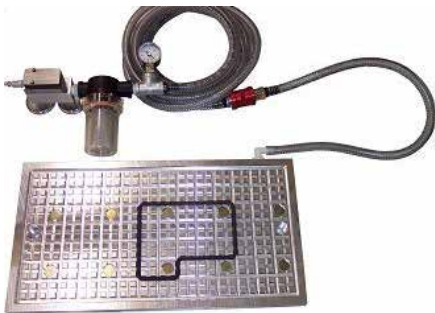

VACUUM CHUCK PACKAGES

The NEMI Vacuum Chucks are an excellent way to add the versatility of vacuum workholding to your machining center, manual milling machine and surface grinder, just to name a few. While the vacuum chuck doesn't replace a traditional machinist vise, it provides a platform for unique workholding strategies not possible otherwise. These packages come complete with our 4.03 CFM Vacuum generator, vacuum hose, fittings, gasket and more to have you up in running in no time. If you need to machine or grind flat plate plastics, aluminum, steel, carbon fiber or other materials, this is the system for you!

Width	Length	# of Ports	Description	P/N
13"	13"	1	13 x 13 Vacuum Chuck Package	1390
8.25"	14"	1	8.25 x 14 Vacuum Chuck	1571
8.25"	14"	1	8.25 x 14 Vacuum Chuck Package	1666
9.5"	17.75"	10	9.5 x 18 Vacuum Chuck Package	1295
12"	17.75"	10	12 x 18 Vacuum Chuck Package	1506
14"	17.75"	20	14 x 18 Vacuum Chuck Package	1507
14"	17.75"	20	14 x 18 Vacuum Chuck Package with parallels	1593
14"	17.75"	20	14 x 18 Vacuum Chuck with Parallels - Chuck Only	1601

VACUUM GRID TABLE

Nemi now offers our Vacuum Grid System integrated with a machine base frame. Build your own cell or machine! These units feature rigid steel tubing construction and are completely plumbed and ready to go. Multiple vacuum zones available.



Width	Length	Description	P/N
2'	4'	2 x 4 Vacuum Grid Machine Base	1406
4'	4'	4 x 4 Vacuum Grid Machine Base	1407
4'	8'	4 x 8 Vacuum Grid Machine Base	1357
5'	10'	5 x 10 Vacuum Grid Machine Base	1408
5'	12'	5 x 12 Vacuum Grid Machine Base	1409



ROUND VACUUM CHUCKS

This vacuum chuck has the ability to hold round workpieces ranging from 1-1/4" diameter to 5-1/8" diameter in increments of .78". It features movable locator pins for quick and easy part location.

O.D.	Height	MIN Dia	MAx Dia	Description	P/N
6"	1"	1.23"	5.11"	Round Vacuum Chuck	1492

Don't see what you need? Give us a call!

VACUUM WORKHOLDING PRODUCTS

GRID TABLES & CHUCKS



MINI VACUUM CHUCK

This mini vacuum chuck is designed for the hobbyist or the professional engraver. These chucks are small and easy to handle. They feature 7/16" groove spacing for those smaller items. Also featured are 36 tapped holes for additional clamping when needed. Package includes 4.03 Vacuum Generator, hose & fittings.

Width	Length	Description	P/N
7.5"	7.5"	Engraver's Vacuum Chuck	1299
7.5"	7.5"	7.5 x 7.5 Mini Vacuum Chuck (Chuck ONLY)	1668
N/A	N/A	Engravers Vacuum Chuck Package	1553

LATHE CHUCK JAWS

The NEMI Vacuum Pod Jaws enable you to even further utilize your 3 jaw chucks! Simply place the part on the jaw faces, apply vacuum and go! We can manufacture jaws to fit most any chuck at most any radius or shape configuration.

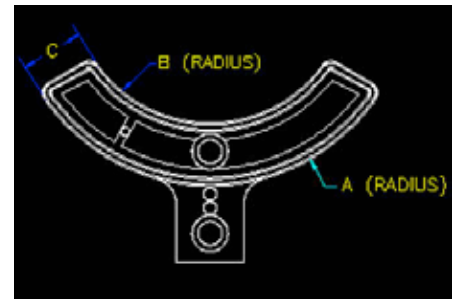

"A"	"B"	"C"	Height	Description	Chuck	P/N
5.8"	3.99"	1.81"	1.625"	SZKA-412 Vacuum Jaws	Rota-S+500	1549
7.65"	4.005"	3.70"	1.625"	SZKA-412 Vacuum Jaws	Rota-S+500	1550

Don't see what you need? Give us a call!

HOW DOES OUR PATENTED SLIDER POD & GRID TABLE WORK?

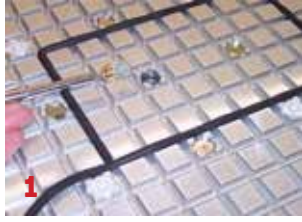

USING THE NEMI GRID TABLE:

- Setting up & using the NEMI Grid table is simple and fast!
- Remove Gold Steel Washer with magnet. (This is your source for vacuum)
- Place a locator pin or vacuum pod over the hole.
- Place material on top of the pod and turn the vacuum on, the locator pin will drop and the vacuum pod will hold the part secure for machining.

AUTO VALVE

- The Auto Valve is shown to the left and is white in color, simply place the pod on top and you have vacuum.

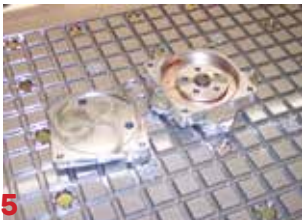
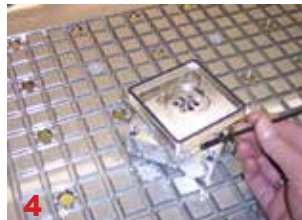
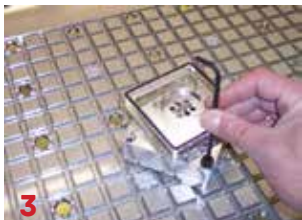

ADJUSTING SLIDER PODS:

- On the bottom side of the slider pod there are two set screws.
- Loosen them, now you can rotate and shift the pod to the position you want.
- Tighten one or both set screws and you're ready to make parts.

REPLACING SLIDER PODS TOP:

- Loosen two set screws on back.
- Shift pod to side and remove (4) flat head screws.
- Remove the top plate.
- Now you can replace with new or custom top.
- Insert (4) Flat head screws and tighten.
- Shift or rotate pod to the position you want.
- Tighten one or both set screws and you're ready to make parts.

VACUUM WORKHOLDING PRODUCTS

VACUUM PODS / SLIDER PODS



WILL NEMI VACUUM PODS FIT MY MACHINE?

NEMI makes bases to fit a wide variety of grid table patterns including Holz-her, SCM/Routech, Homag, Weeke, Heian and more! You can order your Slider Pods with any base at no extra cost! However, there is an extra charge for non-NEMI bases on one piece pods.

Base Size (SQ)	Description	P/N
5"	5" HOMAG/WEEKE/HEIAN BASE	Add-869
5"	5" SCM/Routech BASE	Add-865
4"	4" CMS BASE	Add -1226
4"	4" HOLZ-HER BASE	Add -1222
5"	Anderson Omnitech Base	Add -1346
5.15"	Bima 310 Base	Add -1249
5"	Biesse Mushroom Clamp Base	Add -1521
5"	Biesse Slider Pod Base	Add -1711
4"	4" NEMI Replacement Base	Add -1
5"	5" NEMI Replacement Base	Add -1
6"	6" NEMI Replacement Base	Add -1

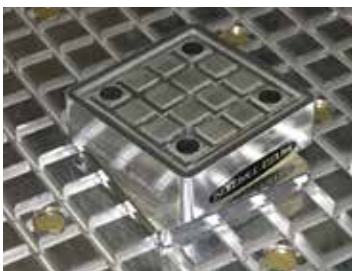

SQUARE VACUUM SLIDER PODS

The NEMI Vacuum Slider Pod can shift .60 in any direction and rotate 360 degrees to hold your parts securely. Each Pod has a replaceable top plate for quick change out. These pods come standard with the NEMI Grid base but are available with a variety of bases to fit most ANY grid table.

See page 14 for available bases.

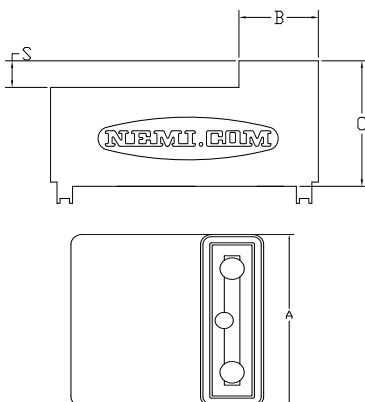

A x B x C x Base Size	Description	P/N
4" x 4" x 1.771" x 4"	4" Square Slider Pod	738
5" x 5" x 1.771" x 5"	5" SQR. Slider Pod	772
6" x 6" x 1.771" x 6"	6" SQR. Slider Pod	771
4" x 4"	4" Replacement Top	Add-3
5" x 5"	5" Replacement Top	Add-3
6" x 6"	6" Replacement Top	Add-3
50 ft roll	Replacement Gasket	794

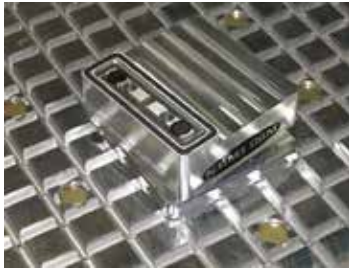

See page 14 for available bases.

STRAIGHT VACUUM SLIDER PODS

The NEMI Vacuum Slider Pod can shift .60 in any direction and rotate 360 degrees to hold your parts secure. Each Pod has a replaceable top plate for quick change out. These pods come standard with the NEMI Grid base but are available with a variety of bases to fit most ANY grid table. Offers a rectangular vacuum zone with a standard 3/8" step.

A x B x C x Base Size	Description	P/N
4" x .75" x 1.771" x 4"	4" x .75" Straight Slider Pod	862
4" x 1" x 1.771" x 4"	4" x 1" Straight Slider Pod	1724
4" x 1.3" x 1.771" x 4"	4" x 1.3" Straight Slider Pod	721
4" x 1.5" x 1.771" x 4"	4" x 1.5" Straight Slider Pod	1118
4" x 1.75" x 1.771" x 4"	4" x 1.75" Straight Slider Pod	1120
4" x 2" x 1.771" x 4"	4" x 2" Straight Slider Pod	733
4" x 3" x 1.771" x 4"	4" x 3" Straight Slider Pod	816
4" x 3.5" x 1.771" x 4"	4" x 3.5" Straight Slider Pod	1256
5" x 1.5" x 1.771" x 5"	5" x 1.5" Straight Slider Pod	986
5" x 1.75" x 1.771" x 5"	5" x 1.75" Straight Slider Pod	980
5" x 2" x 1.771" x 5"	5" x 2" Straight Slider Pod	832
5" x 2.5" x 1.771" x 5"	5" x 2.5" Straight Slider Pod	978
5" x 2.75" x 1.771" x 5"	5" x 2.75" Straight Slider Pod	1717
5" x 3" x 1.771" x 5"	5" x 3" Straight Slider Pod	834
5" x 3.5" x 1.771" x 5"	5" x 3.5" Straight Slider Pod	967
5" x 4" x 1.771" x 5"	5" x 4" Straight Slider Pod	836
6" x 2" x 1.771" x 6"	6" x 2" Straight Slider Pod	839
6" x 3" x 1.771" x 6"	6" x 3" Straight Slider Pod	841
6" x 4" x 1.771" x 6"	6" x 4" Straight Slider Pod	843
6" x 5" x 1.771" x 6"	6" x 5" Straight Slider Pod	845
4" x 4"	4" Replacement Top	Add-3
5" x 5"	5" Replacement Top	Add-3
6" x 6"	6" Replacement Top	Add-3

Don't see what you need? Give us a call!

VACUUM WORKHOLDING PRODUCTS

SLIDER PODS

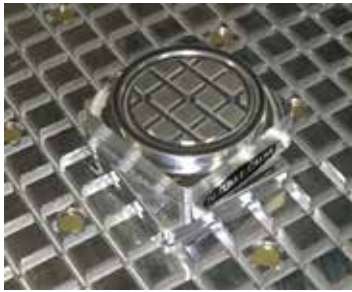

See page 14 for available bases.

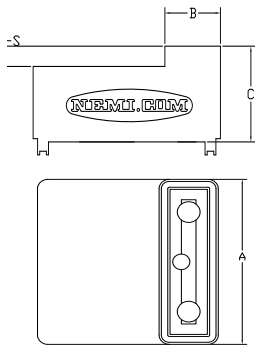

ROUND VACUUM SLIDER PODS

The NEMI Vacuum Slider Pod can shift .60 in any direction and rotate 360 degrees to hold your parts securely. Each Pod has a replaceable top plate for quick change out. These pods come standard with the NEMI Grid base but are available with a variety of bases to fit most ANY grid table. Round vacuum zone with 3/8" step.

A x B x C x Base Size (SQR)	Description	P/N
2.5" DIA. x 1.771" x 4"	2 1/2" Round Slider Pod	736
3" DIA. x 1.771" x 4"	3" Round Slider Pod	728
4" DIA. x 1.771" x 4"	4" Round Slider Pod	735
5" DIA. x 1.771" x 5"	5" Round Slider Pod	837
6" DIA. x 1.771" x 6"	6" Round Slider Pod	846

CORNER VACUUM SLIDER PODS

The NEMI Vacuum Slider Pod can shift .60 in any direction and rotate 360 degrees. Each Pod has a replaceable top plate for quick change out. These pods come standard with the NEMI Grid base but are available with a variety of bases to fit most ANY grid table. "L" shaped vacuum zone with standard 3/8" step.



See page 14 for available bases.

A x B x C x Base Size (SQR)	Description	P/N
4" x .75" x 1.771" x 4"	4" x .75" Corner Slider Pod	860
4" x 1.3" x 1.771" x 4"	4" x 1.3" Corner Slider Pod	720
4" x 1.5" x 1.771" x 4"	4" x 1.5" Corner Slider Pod	1117
4" x 1.75" x 1.771" x 4"	4" x 1.75" Corner Slider Pod	1119
4" x 2" x 1.771" x 4"	4" x 2" Corner Slider Pod	732
4" x 3" x 1.771" x 4"	4" x 3" Corner Slider Pod	817
5" x 1.5" x 1.771" x 5"	5" x 1.5" Corner Slider Pod	987
5" x 1.75" x 1.771" x 6"	5" x 1.75" Corner Slider Pod	992
5" x 2" x 1.771" x 5"	5" x 2" Corner Slider Pod	831
5" x 2.5" x 1.771" x 5"	5" x 2.5" Corner Slider Pod	979
5" x 3" x 1.771" x 5"	5" x 3" Corner Slider Pod	833
5" x 3.5" x 1.771" x 5"	5" x 3.5" Corner Slider Pod	993
5" x 4" x 1.771" x 5"	5" x 4" Corner Slider Pod	835
6" x 2" x 1.771" x 6"	6" x 2" Corner Slider Pod	838
6" x 3" x 1.771" x 6"	6" x 3" Corner Slider Pod	840
6" x 4" x 1.771" x 6"	6" x 4" Corner Slider Pod	842
6" x 5" x 1.771" x 6"	6" x 5" Corner Slider Pod	844
4" x 4"	4" Replacement Top	Add-3
5" x 5"	5" Replacement Top	Add-3
6" x 6"	6" Replacement Top	Add-3
1/8" x 1/8" x 50'	Replacement Gasket	794



Custom tops also available.

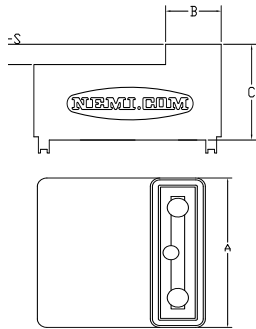

CURVED VACUUM SLIDER POD

The NEMI Curved Slider Pod enables you to hold curved parts such as arched windows and furniture parts with ease. Slider pods shift .60 in any direction and rotate 360 degrees! These pods come standard with the NEMI Grid base but are available with a variety of bases to fit most ANY grid table. Curved vacuum zone with standard 3/8" step.

A x B x C x Radius x Base	Description	P/N
1.5" x 7" x 1.771" x 23.875 4" Base	Curved Slider Pod	1050
1.5" x 8" x 1.771" x 23.875 4" Base	Curved Slider Pod	1051
1.5" x 9" x 1.771" x 23.875 4" Base	Curved Slider Pod	1052
1.5" x 7"	Replacement Top	1050-3
1.5" x 8"	Replacement Top	1051-3
1.5" x 9"	Replacement Top	1052-3



See page 14 for available bases.

DUAL ZONE VACUUM SLIDER POD

The NEMI Dual Zone Vacuum Slider Pod is used to hold two parts or for use along with our Mushroom clamps. These pods come standard with the NEMI Grid base but are available with a variety of bases to fit most ANY grid table.

Size x H Or L	Description	P/N
6.0 SQR. x (2.235 x 5") x 1.771"	6" Sqr Slider Pod Two Zone	1184
5.0 SQR. x (1.73 x 5") x 1.771"	5" Sqr. Slider Pod Two Zone	1045
4.0 SQR. x (1.235 x 5") x 1.771"	4" Sqr. Slider Pod Two Zone	1160
1/8" x 1/8" x 50'	Replacement Gasket	794



See page 14 for available bases.

BLANK TOP SLIDER POD

Blank Top Slider Pods are available for making your own custom tops. Simply machine the top to fit your needs, insert your gasket and you're ready to go! These pods come standard with the NEMI Grid base but are available with a variety of bases to fit most ANY grid table.

Pod Size x H.	Description	P/N
4" x 4" x 1.771	4" Sqr. Blank Top Slider Pod	1161
5" x 5" x 1.771	5" Sqr. Blank Top Slider Pod	1162
6" x 6" x 1.771	6" Sqr. Blank Top Slider Pod	1680
1/8" x 1/8" x 50'	Replacement Gasket	794

VACUUM WORKHOLDING PRODUCTS

ROTO PODS // ONE PIECE

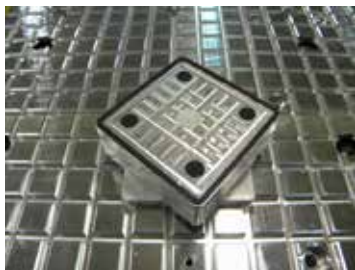

See page 14 for available bases.

ROTO VACUUM PODS

The NEMI roto pods have all the features of our patented Slider Pods including interchangeable tops and 360 degree rotation but do not shift; they rotate only.

Base Size (SQ)	Pod Size	Height	Description	P/N
4"	4" x 4"	1.771"	4" x 4" Square Roto Pod	1388
4"	4" x .75"	1.771"	4" x 3/4" Straight Roto Pod	1394
4"	4" x 1.3"	1.771"	4" x 1.3" Straight Roto Pod	1395
4"	4" x 1.5"	1.771"	4" x 1-1/2" Straight Roto Pod	1396
4"	4" x 1.75"	1.771"	4" x 1-3/4" Straight Roto Pod	1397
4"	4" x 2"	1.771"	4" x 2" Straight Roto Pod	1398
4"	4" x 3"	1.771"	4" x 3" Straight Roto Pod	1399
4"	4" x .75"	1.771"	4" x 3/4" Corner Roto Pod	1400
4"	4" x 1.3"	1.771"	4" x 1.3" Corner Roto Pod	1401
4"	4" x 1.5"	1.771"	4" x 1-1/2" Corner Roto Pod	1402
4"	4" x 1.75"	1.771"	4" x 1-3/4" Corner Roto Pod	1403
4"	4" x 2"	1.771"	4" x 2" Corner Roto Pod	1404
4"	4" x 3"	1.771"	4" x 3" Corner Roto Pod	1405



See page 14 for available bases.

SUPER GRIP ONE PIECE VACUUM PODS

Here are NEMI's lower cost vacuum pod with the great solid holding power of aluminum. This vacuum pod is the same height as all our standard vacuum pods 1.771", but does not rotate and shift like our patented slider pods. They come standard with a NEMI Grid base. All other bases, \$25.00 extra.

A x B x C	Description	P/N
4" x 4" x 1.771"	4" Square One Piece Pod	1072
5" x 5" x 1.771"	5" Square One Piece Pod	1076
6" x 6" x 1.771"	6" Square One Piece Pod	1077
1/8" x 1/8" x 50'	Replacement Gasket	794

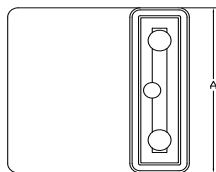
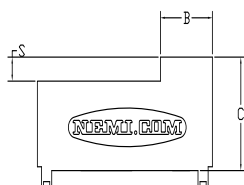

Don't see what you need? Give us a call!

STRAIGHT ONE PIECE VACUUM PODS

NEMI straight one piece pods. These vacuum pods are the same height as all our standard vacuum pods, but do not rotate and shift like our slider pods. Pods have a rectangular vacuum zone; available with 3/8" step or 1-3/8" step.



See page 14 for available bases.

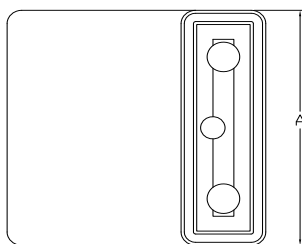
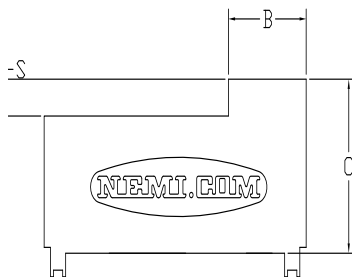

A x B x C x Base Size	'S' Height	Description	P/N
1" x 3" x 1.771" x 4"	3/8"	1" x 3" Straight Pod	1444
1" x 3" x 1.771" x 4"	1-3/8"	1" x 3" Straight Pod	1444-D
4" x .75" x 1.771" x 4"	3/8"	4" x .75" Straight Pod	1078
4" x .75" x 1.771" x 4"	1-3/8"	4" x .75" Straight Pod	1078-D
4" x 1.0" x 1.771" x 4"	3/8"	4" x 1.0" Straight Pod	1569
4" x 1.0" x 1.771" x 4"	1-3/8"	4" x 1.0" Straight Pod	1569-D
4" x 1.25" x 1.771" x 4"	3/8"	4" x 1.25" Straight Pod	1445
4" x 1.25" x 1.771" x 4"	1-3/8"	4" x 1.25" Straight Pod	1445-D
4" x 1.3" x 1.3" x 1.771" x 4"	3/8"	4" x 1.3" x 1.3" Straight	1110
4" x 1.3" x 1.3" x 1.771" x 4"	1-3/8"	4" x 1.3" x 1.3" Straight	1110-D
4" x 1.3" x 1.771" x 4"	3/8"	4" x 1.3" Straight Pod	1079
4" x 1.3" x 1.771" x 4"	1-3/8"	4" x 1.3" Straight Pod	1079-D
4" x 2" x 1.771" x 4"	3/8"	4" x 2" Straight Pod	1080
4" x 2" x 1.771" x 4"	1-3/8"	4" x 2" Straight Pod	1080-D
4" x 3" x 1.771" x 4"	3/8"	4" x 3" Straight Pod	1081
4" x 3" x 1.771" x 4"	1-3/8"	4" x 3" Straight Pod	1081-D
5" x .75" x 1.771" x 4"	3/8"	5" x .75" Straight Pod	1741
5" x .75" x 1.771" x 4"	1-3/8"	5" x .75" Straight Pod	1741-D
5" x 1" x 1.771" x 4"	3/8"	5" x 1" Straight Pod	1742
5" x 1" x 1.771" x 4"	1-3/8"	5" x 1" Straight Pod	1742-D
5" x 1.25" x 1.771" x 4"	3/8"	5" x 1.25" Straight Pod	1743
5" x 1.25" x 1.771" x 4"	1-3/8"	5" x 1.25" Straight Pod	1743-D
5" x 1.5" x 1.771" x 5"	3/8"	5" x 1.5" Straight Pod	1082
5" x 1.5" x 1.771" x 5"	1-3/8"	5" x 1.5" Straight Pod	1082-D
5" x 1.75" x 1.771" x 5"	3/8"	5" x 1.75" Straight Pod	1083
5" x 1.75" x 1.771" x 5"	1-3/8"	5" x 1.75" Straight Pod	1083-D
5" x 2" x 1.771" x 5"	3/8"	5" x 2" Straight Pod	1084
5" x 2" x 1.771" x 5"	1-3/8"	5" x 2" Straight Pod	1084-D
5" x 2.5" x 1.771" x 5"	3/8"	5" x 2.5" Straight Pod	1085
5" x 2.5" x 1.771" x 5"	1-3/8"	5" x 2.5" Straight Pod	1085-D
6" x 2" x 1.771" x 6"	1-3/8"	6" x 2" Straight Pod	1104-D
6" x 3" x 1.771" x 6"	3/8"	6" x 3" Straight Pod	1105
6" x 3" x 1.771" x 6"	1-3/8"	6" x 3" Straight Pod	1105-D
6" x 4" x 1.771" x 6"	3/8"	6" x 4" Straight Pod	1106
6" x 4" x 1.771" x 6"	1-3/8"	6" x 4" Straight Pod	1106-D
6" x 5" x 1.771" x 6"	3/8"	6" x 5" Straight Pod	1107
6" x 5" x 1.771" x 6"	1-3/8"	6" x 5" Straight Pod	1107-D

VACUUM WORKHOLDING PRODUCTS

ONE PIECE PODS



See page 14 for available bases.

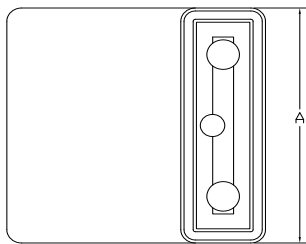
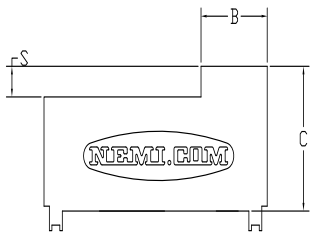

CORNER ONE PIECE VACUUM PODS

NEMI corner one piece pods. These vacuum pods are the same height as all our standard vacuum pods, but do not rotate and shift like our slider pods. Pods have a rectangular base and are available with 3/8" or 1-3/8" step.

A x B x C x Base Size	'S' Height	Description	P/N
4" x .75" x 1.771" x 4"	3/8"	4" x .75" Corner Pod	1093
4" x .75" x 1.771" x 4"	1-3/8"	4" x .75" Corner Pod	1093-D
4" x 1.3" x 1.771" x 4"	3/8"	4" x 1.3" Corner Pod	1094
4" x 1.3" x 1.771" x 4"	1-3/8"	4" x 1.3" Corner Pod	1094-D
4" x 2" x 1.771" x 4"	3/8"	4" x 2" Corner Pod	1095
4" x 2" x 1.771" x 4"	1-3/8"	4" x 2" Corner Pod	1095-D
4" x 3" x 1.771" x 4"	3/8"	4" x 3" Corner Pod	1096
4" x 3" x 1.771" x 4"	1-3/8"	4" x 3" Corner Pod	1096-D
5" x 1.5" x 1.771" x 5"	3/8"	5" x 1.5" Corner Pod	1097
5" x 1.5" x 1.771" x 5"	1-3/8"	5" x 1.5" Corner Pod	1097-D
5" x 1.75" x 1.771" x 5"	3/8"	5" x 1.75" Corner Pod	1098
5" x 1.75" x 1.771" x 5"	1-3/8"	5" x 1.75" Corner Pod	1098-D
5" x 2" x 1.771" x 5"	3/8"	5" x 2" Corner Pod	1099
5" x 2" x 1.771" x 5"	1-3/8"	5" x 2" Corner Pod	1099-D
6" x 2" x 1.771" x 6"	3/8"	6" x 2" Corner Pod	1089
6" x 2" x 1.771" x 6"	1-3/8"	6" x 2" Corner Pod	1089-D
6" x 3" x 1.771" x 6"	3/8"	6" x 3" Corner Pod	1090
6" x 3" x 1.771" x 6"	1-3/8"	6" x 3" Corner Pod	1090-D
6" x 4" x 1.771" x 6"	3/8"	6" x 4" Corner Pod	1091
6" x 4" x 1.771" x 6"	1-3/8"	6" x 4" Corner Pod	1091-D
6" x 5" x 1.771" x 6"	3/8"	6" x 5" Corner Pod	1092
6" x 5" x 1.771" x 6"	1-3/8"	6" x 5" Corner Pod	1092-D
1/8" x 1/8" x 50'	N/A	Replacement Gasket	794

Need a base for your machine? A Custom Pod Top? No problem! Just give us a call. If we don't have it we'll make it! 763.856.2044

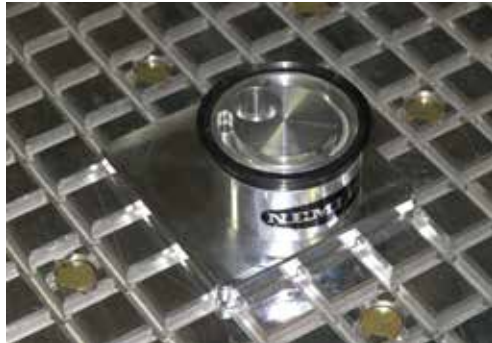

Special sizes available.

ROUND VACUUM PODS

The NEMI Round Vacuum Pod can rotate 360 degrees with detent pins every 45 degrees.

Size Pod Dia x H x Base	Description	P/N
4.94" x 1.771" x 6.08"	x-large Pod W/O Roller	695
4.94" Gasket	695 Replacement Gasket	695-K59-0110
4.19" x 1.771" x 6.08"	Large Pod W/O Roller	679
4.19" Gasket	679 Replacement Gasket	679-K57-0090
3.0" x 1.771" x 4.0"	Large Pod W/O Roller	723
3.0" Gasket	723 Replacement Gasket	723-K53-0065
2.860" x 1.771" x 4.0"	Medium Pod W/O Roller	696
2.860" Gasket	696 Replacement Gasket	696-K52-0055
2.50" x 1.771" x 4.0"	Small Pod W/O Roller	678
2.5" Gasket	678 Replacement Gasket	678-K51-0050

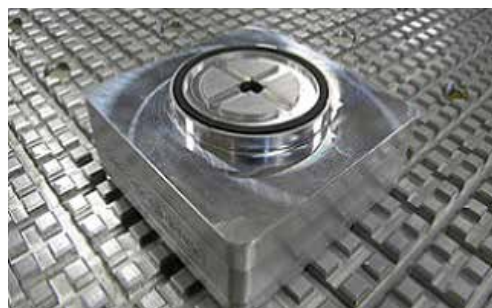

ROUND ONE PIECE VACUUM PODS

The NEMI One Piece Round Vacuum Pod holds your parts secure. This is your low cost workholding solution. These vacuum pods are available in a variety of bases to fit most any machine including Heian, Homag, Weeke, Holzher, Thermwood, Busellato, C.R. Onsrud, Routech, Komo and many others. For that extra bit of holding power on smaller workpieces, check out our vacuum pod spikes. These pods are also available with our auto vacuum valve.

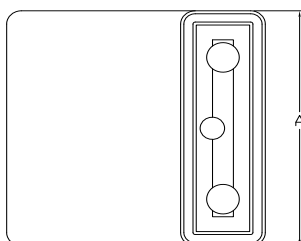
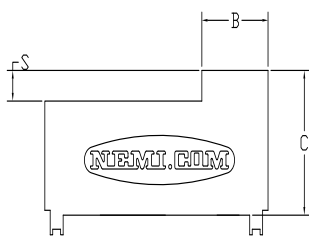

B x C	Base (Sq.)	Description	P/N
2" x 1.771"	4" x 4"	2" Round One Piece Pod	1706
2.5" x 1.771"	4" x 4"	2.5" Round One Piece Pod	1712
3" x 1.771"	4" x 4"	3" Round One Piece Pod	1707
4" x 1.771"	4" x 4"	4" Round One Piece Pod	1708
5" x 1.771"	5" x 5"	5" Round One Piece Pod	1709
6" x 1.771"	6" x 6"	6" Round One Piece Pod	1710

We make pods & bases to fit ANY grid table. Call for pricing today!

VACUUM WORKHOLDING PRODUCTS

ONE PIECE PODS

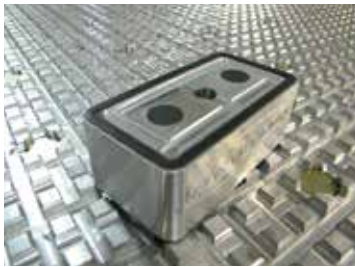
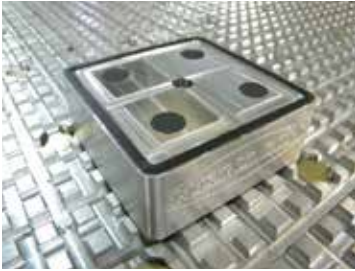

Other sizes & bases available.

LOW PROFILE VACUUM PODS

These one piece vacuum pods feature the same rigid quality as our standard one piece pods but are at a low profile height for applications where "Z" travel and/or clearance may be limited.

Base Size	Pod Size	Height	Description	P/N
3-3/8" x 3-3/8"	3-3/8" x 3-3/8"	.984" (25mm)	SCM/Routech/Morbidelli Low Profile Pod	1575
3-3/8" x 1-13/16"	3-3/8" x 1-13/16"	.984" (25mm)	SCM/Routech/Morbidelli Low Profile Pod	1574
4" x 4"	4" x 4"	.708"	4" x 4" Low Profile Vacuum Pod	1690
4" x 4"	4" x .75"	.708"	4" x .75" Straight Low Profile Vacuum Pod	1693
4" x 4"	4" x .75"	.708"	4" x .75" Corner Low Profile Vacuum Pod	1694
4" x 4"	4" x 1"	.708"	4" x 1" Straight Low Profile Vaccum Pod	1695
4" x 4"	4" x 1"	.708"	4" x 1" Corner Low Profile Vaccum Pod	1696
4" x 4"	4" x 2"	.708"	4" x 2" Straight Low Profile Vaccum Pod	1691
4" x 4"	4" x 2"	.708"	4" x 2" Corner Low Profile Vaccum Pod	1692
4" x 4"	4" x 3"	.708"	4" x 3" Straight Low Profile Vaccum Pod	1697
4" x 4"	4" x 3"	.708"	4" x 3" Corner Low Profile Vaccum Pod	1698
1/8 x 1/8 x 50'	Replacement Gasket	N/A	Replacement Gasket	794

Don't see what you need? Give us a call!

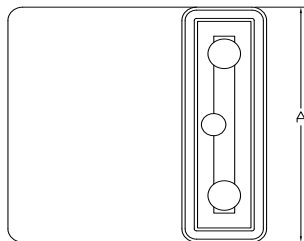
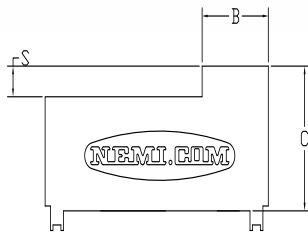

EXTRA LONG ONE PIECE POD SERIES

These NEMI rectangular one piece vacuum pods are a great solution for applications using long materials. Rather than place several square/straight/corner pods you can place just one pod, trimming even more time off of your setups. Parts vary in length? Use one of these made to your shortest part, add square pods w/ auto valves to accommodate the varying lengths!

These pods are our standard height and can be used in conjunction with our other vacuum pods, locator pins, etc. Proudly made in the USA!

Please select from our standard configurations below or as always if you don't see the size you need, give us a call and we'll make it!

A x B x C	Base Size	Description	P/N
4" x 18" x 1.771"	4" x 18"	4" x 18" One Piece Pod	1684
4" x 36" x 1.771"	4" x 36"	4" x 36" One Piece Pod	1683
5" x 18" x 1.771"	5" x 18"	5" x 18" One Piece Pod	1682
5" x 36" x 1.771"	5" x 36"	5" x 36" One Piece Pod	1681
N/A	N/A	Replacement Gasket	794

RISER PLATES

The Vacuum Pod and Locator pin riser plates are a modular design that lift vacuum pods to a greater height to allow horizontal milling and boring.



Height	Pod Size Desc.	P/N
.59"	4" Slider Riser	729
1.5"	4" Slider Riser	777
1.75"	4" Slider Riser	1677
1.9685"	4" Slider Riser	1732
3.084"	4" Slider Riser	778
4.229"	4" Slider Riser	1719
.59"	5" Slider Riser	779
1.5"	5" Slider Riser	780
3.084"	5" Slider Riser	781
4.229"	5" Slider Riser	1718
.59"	6" Slider Riser	782
1.5"	6" Slider Riser	783
3.084"	6" Slider Riser	784
4.229"	6" Slider Riser	1720

VACUUM WORKHOLDING PRODUCTS

RISERS

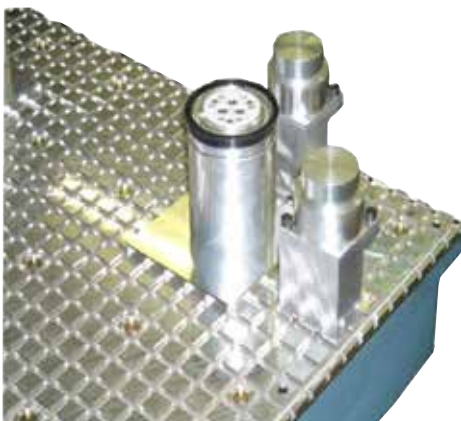

RISER PLATES

The Vacuum Pod and Locator pin riser plates are a modular design that lift vacuum pods to a greater height to allow for horizontal milling and boring.

Height	Pod Size Desc.	P/N
.59"	4.0 Sqr. Mushroom	968
1.5"	4.0 Sqr. Mushroom	969
50mm	4.0 Sqr. Mushroom	1543
3.084"	4.0 Sqr. Mushroom Clamp	970
.59"	5.0 Sqr. Mushroom Clamp	971
1.5"	5.0 Sqr. Mushroom Clamp	972
3.084"	5.0 Sqr. Mushroom Clamp	973
.59"	6.0 Sqr. Mushroom Clamp	974
1.5"	6.0 Sqr. Mushroom Clamp	975
3.084"	6.0 Sqr. Mushroom Clamp	976
.59"	4.94 Dia. 695 Pod Riser	706
1.5"	4.94 Dia. 695 Pod Riser	707
3.084"	4.94 Dia. 695 Pod Riser	708
.59"	4.19 Dia. 679 Pod Riser	673
1.5"	4.19 Dia. 679 Pod Riser	674
3.084"	4.19 Dia. 679 Pod Riser	675
.59"	3.0 Dia. 723 Pod Riser	785
1.5"	3.0 Dia. 723 Pod Riser	786
3.084"	3.0 Dia. 723 Pod Riser	787
.59"	Popup Pin Riser	700
1.5"	Popup Pin Riser	701
3.084"	Popup Pin Riser	702
.59"	2.86 Dia. 696 Pod Riser	709
1.5"	2.86 Dia. 696 Pod Riser	710
3.084"	2.86 Dia. 696 Pod Riser	711
.59"	2.5 Dia. 678 Pod Riser	703
1.5"	2.5 Dia. 678 Pod Riser	704
3.084"	2.5 Dia. 678 Pod Riser	705

Don't see what you need? Give us a call!



MODULAR STACKABLE VACUUM PODS

NEMI's practical, modular vacuum workholding solution!

Base Size	Pod Size	Height	Description	P/N
4" x 4"	4" x 4"	1.771"	4x4 Stackable Vacuum Pod	1446
4" x 4"	4" x 4"	1.771"	4x4 Stackable Pod— Homag/Heian/Weeke base	1560

These versatile Vacuum Pods are our standard pod height but can be stacked to achieve different heights! Remove and replace the non-adhesive gasket for a variety of configurations. Multiple pods in one.

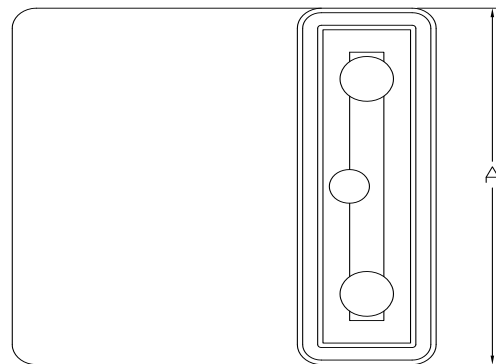
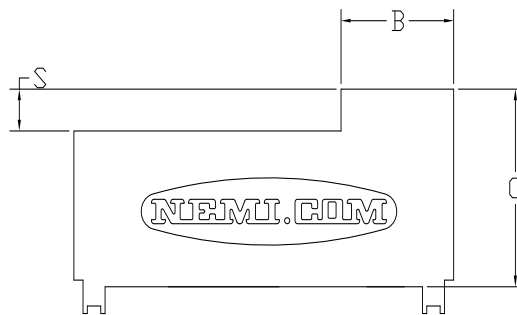

Don't see what you need? Give us a call!

VACUUM WORKHOLDING PRODUCTS

"T" SHAPE PODS // FACE FRAME PODS

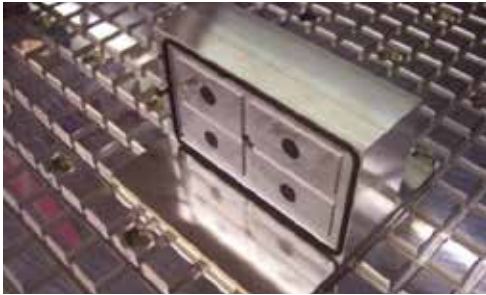

"T" SHAPE POD

The NEMI T-Shape Pod can hold your parts vertical on both sides! Now you can perform first and second operations simultaneously or double up on production. They also include a removable locator pin stop. These pods are available with a variety of bases to fit most any grid table!

Pod Size x Base Size (SQR.)	Description	P/N
3.5" x 6" x 4"	4" Base T-Shape Pod	1165
3.5" x 6" x 5"	5" Base T-Shape Pod	1164
2" x 6" x 6"	6" Base T-Shape Pod	1287
3.5" x 6" x 6"	6" Base T-Shape Pod	1163
3.5" x 6" x 4"	4" T-Shape w/Base Vacuum	1168
3.5" x 6" x 5"	5" T-Shape w/Base Vacuum	1167
3.5" x 6" x 6"	6" T-Shape w/Base Vacuum	1166
5" x 6" x 6.335" x 6" sqr base	5" Axis T-Shape Vacuum Pod	1676
5" x 6" x 6.335" x 6" sqr base	5" Axis T-Shape Vacuum Pod with Autovalve	1676-1520
3.5" x 6"	Replacement Top	Add -3
1/8" x 1/8" x 50'	Replacement Gasket	794



FACE FRAME VACUUM PODS

This unique vacuum pod from NEMI allows you to do multiple operations concurrently using the same pod! Each pod is custom made to your specifications. Use the same size stock on both sides or machine two completely different sizes of material. You name it, we'll make it.

Base Size	Vertical Size	Horizontal Size	P/N
5" x 5"	1-3/8"	2"	1203

Don't see what you need? Give us a call!



CONVEX/CONCAVE VACUUM PODS

The NEMI Convex & Concave Adjustable pods provide superior flexibility and holding power. Height is adjustable in 1/8" increments. The tops pivot 130 degrees. These pods also feature our patented Slider Pod base allowing them to shift .6" in any direction after positioned on the grid. Standard tops shown but, as always, we can accommodate any custom needs you may have.



Base Size (SQR)	Top Size	Height Range	Description	P/N
4" x 4"	1-1/2" x 4"	7-1/4" to 9-3/4"	Convex/Concave Adjustable Pod	1243
4" x 4"	1-1/2" x 4"	9-3/4" to 14-1/4"	Convex/Concave Adjustable Pod	1244



5 AXIS STACKABLE VACUUM PODS

These pods can be stacked to achieve different heights as well as dynamically gasketed to allow different size materials to use the same pod!

Simply move the non adhesive gasket to the desired groove or remove completely to stack!



Pod Size	Height	Base	Description	P/N
6" x 6"	6"	6" sq	6" x 6" Stackable 5 Axis Vacuum Pod	1582
6" x 6"	9"	6" sq	6" x 6" Stackable 5 Axis Vacuum Pod	1738
6" x 6"	12"	6" sq	6" x 6" Stackable 5 Axis Vacuum Pod	1740
N/A	N/A	N/A	Replacement Gasket	1285
N/A	N/A	N/A	Replacement Base Gasket 1/8" x 1/8" x 50'	794



Custom sizes available. See page 14 for available bases.

Don't see what you need? Give us a call!

VACUUM WORKHOLDING PRODUCTS

CLAMPS



See page 14 for available bases.

VACUUM MUSHROOM CLAMP

The NEMI Vacuum Mushroom Clamp is designed to hold your parts securely using vacuum. The Mushroom pod has a travel of 1/4" and can hold parts up to 2.25 thick.

Size Dia x H.	Description	P/N
4.0 SQR. x 1.771"	Mushroom Clamp	671
5.0 SQR. x 1.771"	Mushroom Clamp	667
6.0 SQR. x 1.771"	Mushroom Clamp	668
SQR.	SQR. Top Clamp.	SQRTOP



See page 14 for available bases.

DUAL ZONE VACUUM SLIDER POD W/FENCE

This NEMI Dual Zone Slider Pod features a built in fence in the center. Use to hold two parts and/or in conjunction with our mushroom clamps. These pods come standard with the NEMI Grid base but are available with a variety of bases to fit most ANY grid table.

Pod Size (SQR)	Zones (W x L)	Description	P/N
5"	2-1/2" x 5"	5" Dual Zone Slider Pod w/Fence	1159

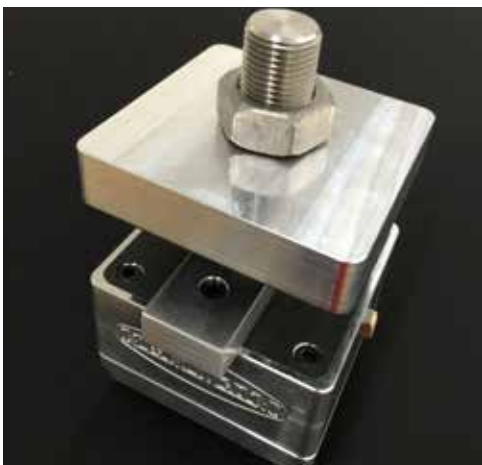

MUSHROOM CLAMP SPACERS

The NEMI Vacuum Mushroom Clamp Spacers are used to space parts out from the clamping area.

Size	Description	P/N
3" x 2" x 1/2" Thick	Mushroom Clamp Spacer	1131
1" 1/4" x 5" x 1/2" Thick	5" Mushroom Clamp Fence	1149
2" Round x 1/2" Thick	Mushroom Clamp Spacer	1146
3" Round x 1/2" Thick	Mushroom Clamp Spacer	1147
4" Round x 1/2" Thick	Mushroom Clamp Spacer	1148



Don't see what you need? Give us a call!



VACUUM MUSHROOM CLAMP KIT

The NEMI Vacuum Mushroom Clamp kit! This kit is ready to locate and hold your parts securely using vacuum. The best pick for holding stiles and rails! The Mushroom pod has a travel of 1/4" and can hold parts up to 2.25 thick with our standard pod. These pods come standard with the NEMI Grid base but are available with a variety of bases to fit most ANY grid table.

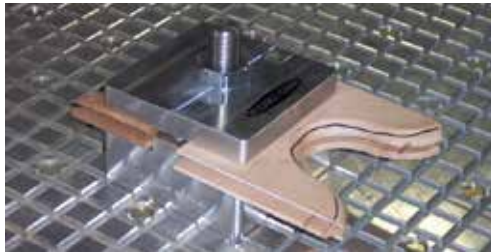

Size x H Or L	Description	Qty.	P/N
5.0 SQR. x (1.73 x 5") x 1.771	5" Sqr. Slider -Two Zone	1	1045
5.0 SQR. x 1.771	Mushroom Clamp	2	667
5.0 x 1.25	Mushroom Clamp Fence	2	1149

MECHANICAL VISES

Do you have some rough blanks or other workpieces you just can't seem to hold with vacuum? Check out these vises from NEMI. These vises can be used on Biesse Rover PTP machines as well as the NEMI grid and many other flat grid table machines! Vise is operated via 9/16" socket. Use your air ratchet for quick clamping and unclamping!



Vise Size W x L	Base Size (sq)	Capacity	Type	Description	P/N
5.19 SQR	N/A	0" -2.25"	Alum	Mechanical Vise - Biesse PTP Top Only	1651
5.19 SQR	6"	0" -2.25"	Alum	Mechanical Vise - NEMI Grid Table	1651-771
5.19 SQR	6"	0" -2.25"	Alum	Mechanical Vise - Homag/ Weeke/Heian Grid Table	1651-869
5.19 SQR	6"	0" - 4.3"	Alum	Mechanical Vise - Pod and Rail Base - Whole Pod	1727
7.19 SQR	N/A	0" - 4.3"	Alum	Mechanical Vise - Biesse PTP Top Only	1729
7.19 SQR	6"	0" - 4.3"	Alum	Mechanical Vise - NEMI Grid Table	1729-771
7.19 SQR	6"	0" - 4.3"	Alum	Mechanical Vise - Homag/ Weeke/Heian Grid Table	1729-869



VISE PLATE VACUUM POD BASE

The NEMI Grid Vise Plate adds even more versatility to our Grid System! Simply mount your vise to this plate, place on Grid and you're ready to go!

Length	Width	P/N
17"	10"	1188

NOTE: Standard model features 7.5" between bolt centers.

VACUUM WORKHOLDING PRODUCTS

VICES

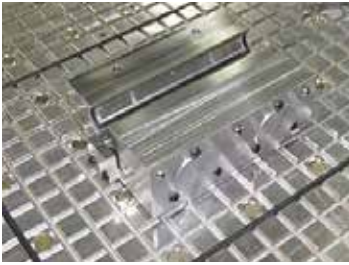

NOTE: Other tube sizes available.

VACUUM TUBE VISE

The NEMI Vacuum Tube Vise is the perfect solution for applications where machining of thin wall tubing is required. The unique feature about this vise is that vacuum actually clamps the tube with outward and inward force simultaneously using (2) individual vacuum circuits. The first circuit closes the jaws to a solid stop. Once the jaws close the second circuit applies vacuum through the jaws, drawing the tube against the jaws. This prevents any distortion of the tube due to clamping pressure. Call for a quote!

Length	Width	Height	Tube Dia	Description	P/N
8"	6"	3.25"	1.125"	Vacuum Tube Vise	1410



Custom sizes & bases available.

MODULAR GRID VISE

This modular grid vise clamp has a length capacity limited only by the size of your grid table. The solid jaw 'pod' can be placed at virtually any distance from the movable jaw pod. Perfect for those extrusions!

Base Size	Height	Jaw Height	Description	P/N
5" x 5"	.49"	1-1/4"	NEMI Modular Grid Vise	1361
5" x 5"	.49"	1-1/4"	Grid Vise HOMAG/Heian/Weeke Base	1361-869
5" x 5"	.49"	1-1/4"	Grid Vise w/SCM Base	1361-865

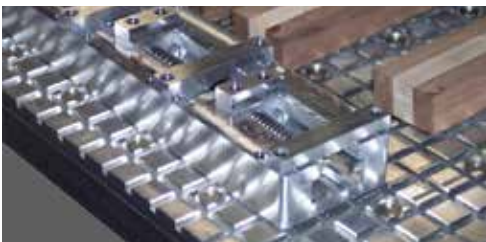

MULTI PART VISE

The NEMI Multi Part Vise holds your parts in place even if they are not the same size. Vise clamps are able to hold up to 12 parts of varying sizes at the same time!

Size W x L x H	Type	Description	P/N
4" x 48" x 1.771"	Alum.	Vise MPV	983-48
4" x 60" x 1.771"	Alum	Vise MPV	983-60
.75" x .50" x 4"	Alum	Vise Jaw Fixed	983-J
.75" x .50" x 4"	Alum	Vise Jaw Movable	983-M

Special Sizes Also Available.



Don't see the size you need? Give us a call and we'll make it!

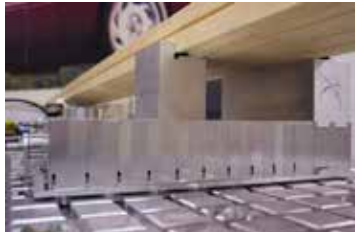

6" VACUUM VISE

Tooling up your router can a time consuming task. With NEMI'S new 6" Vacuum Vise tooling up becomes a lot easier. Vise jaws are available in several sizes and can even be customized. Modular NEMI Vacuum fixtures are designed to hold parts securely in place using vacuum. Simply remove a washer with a magnet, place your vise or pods on top of the vacuum grid table and you are ready to go! The NEMI Vise matches the vacuum pod height of 1.771".

Size W x L	Type	Description	P/N
6" x 9"	Alum.	6" Vacuum Vise	821
1/2" x 1/2" x 6"	Alum.	Vise Jaw Non Movable	821-NON
1/2" x 1/2" x 6"	Alum	Vise Jaw Movable	821-MOV

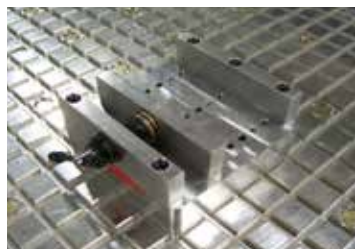

See page 14 for available bases.

SLIDER VISES

This handy Vise Top from NEMI combines the rigid security of mechanical clamping and is a great addition to our patented slider pod base. The solid jaw is adjustable in 1/2" increments.

Top Size	Base Size	Capacity	Jaw Height	Description	P/N
5" x 5"	5" x 5"	0" - 3-1/8"	1-1/4"	Vise (Top ONLY)	1245
5" x 8"	5" x 5"	0" - 6-1/8"	1-1/4"	Vise (Top ONLY)	1255
5" x 12"	5" x 5"	0" - 10-1/8"	1-1/4"	Vise (Top ONLY)	1257
5" x 5"	5" x 5"	0" - 3-1/8"	1-1/4"	Slider Vise Pod	1512
5" x 8"	5" x 5"	0" - 6-1/8"	1-1/4"	Slider Vise Pod	1513
5" x 12"	5" x 5"	0" 10-1/8"	1-1/4"	Slider Vise Pod	1514
5" x 5"	5" x 5"	0" - 3-1/8"	1-1/4"	1 pc. Vise Pod	1515
5" x 8"	5" x 5"	0" - 6-1/8"	1-1/4"	1 pc. Vise Pod	1516
5" x 12"	5" x 5"	0" 10-1/8"	1-1/4"	1 pc. Vise Pod	1517



The photo above illustrates the NEMI Vise Top used in conjunction with the NEMI Modular Locator Pin and NEMI Slider Vacuum Pods.



Use the NEMI Mechanical Vise top to securely clamp hard to hold materials in conjunction with our standard Slider or One Piece Vacuum Pods.

VACUUM WORKHOLDING PRODUCTS

LOCATION DEVICES



Custom pins also available.

PART LOCATOR PINS MODULAR

The NEMI Locator Pins are available in Vacuum or Solid. The locator pins are designed to locate your parts with ease. Push your part against the popup pin, turn on your vacuum and pin drops down allowing for full, 5-sided machining.

Size Dia x H. x H. Retracted	Description	P/N
2.372" x 2.17"	Solid Pin	699
2.372" x 1.971" x 1.345"	Popup Pin Short	670
2.372" x 2.561" x 1.611" Note: Used with .59" riser.	Popup Pin	748

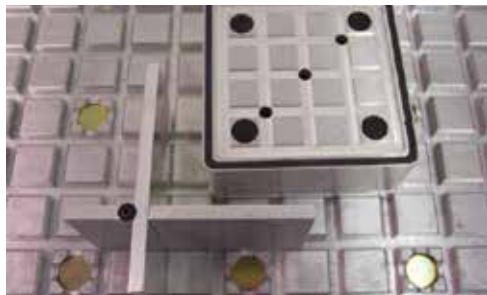

FIXED LOCATOR PLATE

NEMI Fixed Locator Plates are designed to locate your parts with ease. Push your part against the plate, turn on your vacuum and start cutting your part. Locator Plates are made from aluminum and precision machined on CNC machines.

Size W x L x H	Description	P/N
4.181" x 4.181" x 2.5"	Grid Fixed Locator Plate	824



PINCH BLOCK

NEMI Pinch Blocks are designed to "pinch" parts or pods in the grid table to maintain exact position when loading and unloading or when the vacuum is off. Simply place the Pinch Block in the grid table slot and turn the screw.

Size	Type	Description	P/N
.25" x 3.0" x .562"	Alum.	Pinch Block	852
1.25" x 2.0" x .562"	Alum.	Pinch Block - SCM/Routech	852-865



Don't see the size you need? Give us a call and we'll make it!



GRID WORK STOP

The NEMI Precision Grid Work Stops enable you to accurately place plates to be machined or spoilboards. Made of billet aluminum, these stops protrude 1/2" above the grid surface and are removable once the material is placed. Great for production jobs!

Length	Width	Height	Description	P/N
.2-1/4"	1-3/4"	.5"	Grid Work Stop	1518



GRID LOCATOR PLUG

The NEMI Locator Plug is a basic upgrade to the plugs supplied with your NEMI Grid Table. These plugs protrude above the table top and provide an excellent means of locating flat plates or spoil boards. They are equipped with an extra O-ring seal for environments where metal chips and thin coolant leakage may be a problem.

Diameter	Height	Description	P/N
.705"	.725"	Grid Locator Plug	1182



SCM GRID LOCATOR PLUG

Attention all SCM/Routtech/Holz-Her/Morbidelli owners! Check out this handy accessory from NEMI. This port plug allows you to locate parts or blanks right on your grid table! These port plugs are made of steel and screw into your existing ports for accurate positioning every time.

Diameter	Height	Description	P/N
.5/8"	1"	SCM Grid Locator Plug	1511

VACUUM WORKHOLDING PRODUCTS

POD & RAIL

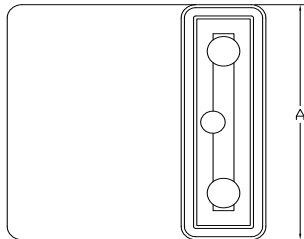
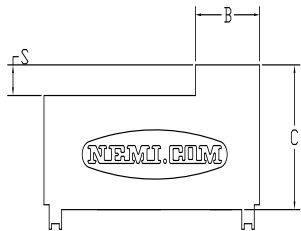

HOMAG/WEEKE POD & RAIL SLIDER PODS

Add the versatility of the NEMI Vacuum Slider Pod System to your Homag/Weeke point to point pod & rail machine! These pods can shift .6 in any direction and rotate 360 degrees. Standard height is 100mm.

A x B	Height	Base (SQR)	Description	P/N
4" x .75"	100 mm	5"	Straight Slider Pod & Rail Pod	1411
4" x 1.3"	100 mm	5"	Straight Slider Pod & Rail Pod	1412
4" x 1.5"	100 mm	5"	Straight Slider Pod & Rail Pod	1413
4" x 1.75"	100 mm	5"	Straight Slider Pod & Rail Pod	1414
4" x 2"	100 mm	5"	Straight Slider Pod & Rail Pod	1415
4" x 3"	100 mm	5"	Straight Slider Pod & Rail Pod	1416
4" x 3.5"	100 mm	5"	Straight Slider Pod & Rail Pod	1417
5" x 1.5"	100 mm	5"	Straight Slider Pod & Rail Pod	1418
5" x 1.75"	100 mm	5"	Straight Slider Pod & Rail Pod	1419
5" x 2"	100 mm	5"	Straight Slider Pod & Rail Pod	1420
5" x 2.5"	100 mm	5"	Straight Slider Pod & Rail Pod	1421
5" x 3"	100 mm	5"	Straight Slider Pod & Rail Pod	1422
5" x 3.5"	100 mm	5"	Straight Slider Pod & Rail Pod	1423
5" x 4"	100 mm	5"	Straight Slider Pod & Rail Pod	1424
4" x .75"	100 mm	5"	Corner Slider Pod & Rail Pod	1425
4" x 1.3"	100 mm	5"	Corner Slider Pod & Rail Pod	1426
4" x 1.5"	100 mm	5"	Corner Slider Pod & Rail Pod	1427
4" x 1.75"	100 mm	5"	Corner Slider Pod & Rail Pod	1428
4" x 2"	100 mm	5"	Corner Slider Pod & Rail Pod	1429
4" x 3"	100 mm	5"	Corner Slider Pod & Rail Pod	1430
5" x 1.5"	100 mm	5"	Corner Slider Pod & Rail Pod	1431
5" x 1.75"	100 mm	5"	Corner Slider Pod & Rail Pod	1432
5" x 2"	100 mm	5"	Corner Slider Pod & Rail Pod	1433
5" x 2.5"	100 mm	5"	Corner Slider Pod & Rail Pod	1434
5" x 3"	100 mm	5"	Corner Slider Pod & Rail Pod	1435
5" x 3.5"	100 mm	5"	Corner Slider Pod & Rail Pod	1436
5" x 4"	100 mm	5"	Corner Slider Pod & Rail Pod	1437
4" x 4"	100 mm	5"	Square Slider Pod & Rail Pod	1438
5" x 5"	100 mm	5"	Square Slider Pod & Rail Pod	1439
N/A	100 mm	5"	Slider Pod & Rail Base	1294

Homag/Weeke products continued on the next page...

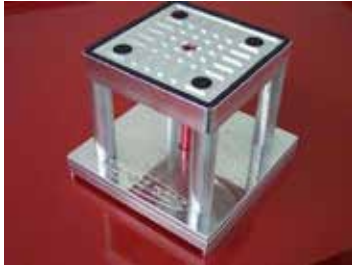

4 x 4 Square pod shown.

Add – 50 to P/N when ordering 50mm height.

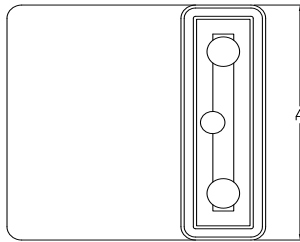
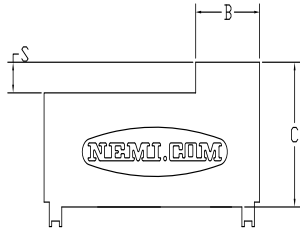

HOMAG/WEEKE ONE PIECE POD & RAIL VACUUM PODS

These NEMI vacuum cups allow you to add the quality, versatility and stability of the NEMI vacuum cups to your Homag/Weeke point to point pod & rail machine! See table for stock sizes.

A x B	C	Base (SQR)	Description	P/N
4" x .75"	100 mm	5"	Straight Pod & Rail Pod	1301
4" x 1.3"	100 mm	5"	Straight Pod & Rail Pod	1302
4" x 2"	100 mm	5"	Straight Pod & Rail Pod	1303
4" x 3"	100 mm	5"	Straight Pod & Rail Pod	1304
5" x 1.5"	100 mm	5"	Straight Pod & Rail Pod	1305
5" x 1.75"	100 mm	5"	Straight Pod & Rail Pod	1306
5" x 2"	100 mm	5"	Straight Pod & Rail Pod	1307
5" x 2.5"	100 mm	5"	Straight Pod & Rail Pod	1308
5" x 3"	100 mm	5"	Straight Pod & Rail Pod	1309
5" x 3.5"	100 mm	5"	Straight Pod & Rail Pod	1310
5" x 4"	100 mm	5"	Straight Pod & Rail Pod	1311
4" x .75"	100 mm	5"	Corner Pod & Rail Pod	1312
4" x 1.3"	100 mm	5"	Corner Pod & Rail Pod	1313
4" x 2"	100 mm	5"	Corner Pod & Rail Pod	1314
4" x 3"	100 mm	5"	Corner Pod & Rail Pod	1315
5" x 1.5"	100 mm	5"	Corner Pod & Rail Pod	1316
5" x 1.75"	100 mm	5"	Corner Pod & Rail Pod	1317
5" x 2"	100 mm	5"	Corner Pod & Rail Pod	1318
5" x 2.5"	100 mm	5"	Corner Pod & Rail Pod	1319
5" x 3"	100 mm	5"	Corner Pod & Rail Pod	1320
5" x 3.5"	100 mm	5"	Corner Pod & Rail Pod	1321
5" x 4"	100 mm	5"	Corner Pod & Rail Pod	1322
4" x 4"	100 mm	5"	Square Pod & Rail Pod	1323
5" x 5"	100 mm	5"	Square Pod & Rail Pod	1324
N/A	N/A	5"	Replacement Base	1300

Don't see what you need? Give us a call!

VACUUM WORKHOLDING PRODUCTS

POD & RAIL

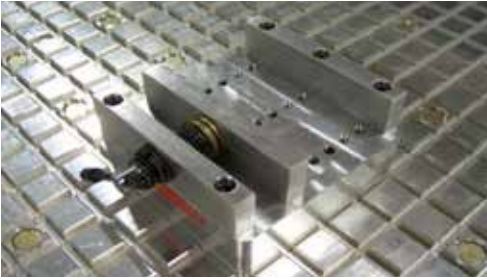

HOMAG/WEEKE SLIDER VISES

The NEMI slider vice combines secure holding with pod and rail systems.

The solid jaw is adjustable in 1/2" increments.

Pod Size	Jaw Height	Base (SQR)	Capacity	Description	P/N
5" x 8"	1.25"	5"	0" - 6.125"	Pod and Rail Slider Vise	1725
5" x 12"	1.25"	5"	0" - 10.125"	Pod and Rail Slider Vise	1726



WEEKE VANTECH VACUUM PODS

NEMI has an inexpensive solution that can open up new opportunities for your Vantech! These pods are designed to fit over the blocks machined in your existing table! A few of these combined with our 10 port vacuum manifold (p/n 1194-10) and you're ready to go.

Size	Height	Description	P/N
3.7795 (96mm)	.6299" (16mm)	Weeke Vantech Vacuum Pod	1554



Don't see what you need? Give us a call!

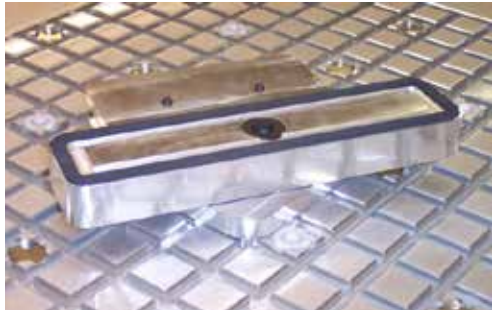

NOTE: Plastic gear NOT included.

BIESSE VACUUM POD TOP & BASE

These NEMI Vacuum Pods fit on a Biesse Point to Point. The vacuum pods rotate every 15 Deg. Pricing below is for the top plate or base only, as specified. With the NEMI base, you can use your Biesse point to point vacuum pods on your CNC router!

Size W x L x H	Description	P/N
1.5" x 6.5" x 1.144"	Rec Biesse Pod	1186
1.5" x 8.25" x 1.144"	Rec. Biesse Pod	1047
1.5" x 13" x 1.144"	Rec. Biesse Pod	1046
2" x 6.5" x 1.144"	Rec. Biesse Pod	1141
2" x 8" x 1.144"	Rec Biesse Pod	1187
2" x 8.25" x 1.144"	Rec. Biesse Pod	1039
2" x 5" x 1.144"	Rec. Biesse Pod	1056
3" x 5" x 1.144"	Rec. Biesse Pod	1055
4" x 5" x 1.144"	Rec. Biesse Pod	1054
5" x 5" x 1.144"	Sqr. Biesse Pod	1053
2.5" DIA. x 5" x 1.144"	Round Biesse Pod	1057
3" DIA. x 5" x 1.144"	Round Biesse Pod	1058
5" DIA. x 5" x 1.144"	Round Biesse Pod	1059
6" DIA. x 6" x 1.144"	Round Biesse Pod	1060
1.5x7" x 23.875" Rad x1.144"	Radius Biesse Pod	1061
1.5" x 8x23.875" Rad x1.144	Radius Biesse Pod	1062
1.5" x 9" x 23.875" Rad x1.144"	Radius Biesse Pod	1063
2" x 2" x 1.144"	Corner Biesse	1064
3" x 3" x 1.144"	Corner Biesse	1065
4" x 4" x 1.144"	Corner Biesse	1066
5" x 5" x .627"	Biesse Pod Base	1042
5" x 8" x 1.144"	Mechanical Vise Pod	1556
1.625" x 3" x 48mm	Biesse Rover A	1685
2.25" x 4.5" x 48 mm	Biesse Rover A	1686
1.625" x 5.190" x 48mm	Biesse Rover A	1687
4.5" x 4.5" x 48mm	Biesse Rover A	1688
1.625" x 3" x 48mm	Biesse Rover A	1689

Don't see what you need? Give us a call!

VACUUM WORKHOLDING PRODUCTS

LOCATOR PIN PODS

LOCATOR PIN POD

The NEMI Locator Pod has locator pin stops built in to the pod. Simply locate the workpiece against the stops, apply vacuum and the stops drop down out of the way! Release vacuum and the stops return to the up position.

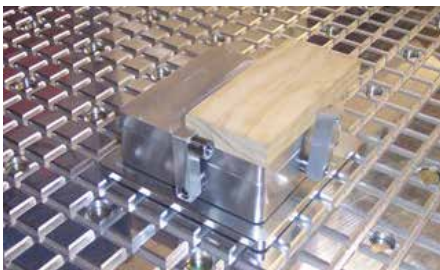
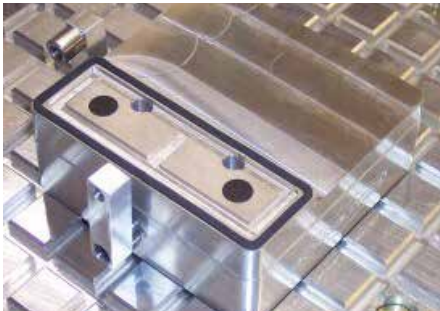

Vacuum OFF, locator pins "up"

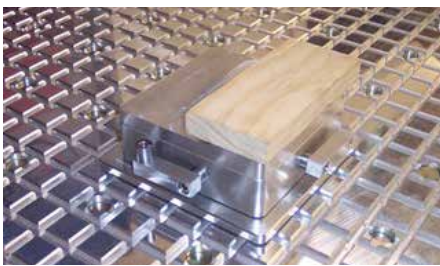

Vacuum ON, locator pins "down"

Pod Size x H. x Base Size (SQR.)	Description	P/N
5" x 1.5" x 1.771" x 5"	5" x 1.5" Straight Pod - One Stop	986-1157-1
5" x 1.75" x 1.771" x 5"	5" x 1.75" Straight Pod - One Stop	980-1157-1
5" x 2" x 1.771" x 5"	5" x 2" Straight Pod - One Stop	832-1157-1
5" x 2.5" x 1.771" x 5"	5" x 2.5" Straight Pod - One Stop	978-1157-1
5" x 3" x 1.771" x 5"	5" x 3" Straight Pod - One Stop	834-1157-1
5" x 3.5" x 1.771" x 5"	5" x 3.5" Straight Pod - One Stop	967-1157-1
5" x 4" x 1.771" x 5"	5" x 4" Straight Pod - One Stop	836-1157-1
5" x 5" x 1.771" x 5"	5" x 5" Square Pod - One Stop	772-1157-1
5" x 1.5" x 1.771" x 5"	5" x 1.5" Straight Pod - Two Stops	986-1157-2
5" x 1.75" x 1.771" x 5"	5" x 1.75" Straight Pod - Two Stops	980-1157-2
5" x 2" x 1.771" x 5"	5" x 2" Straight Pod - Two Stops	832-1157-2
5" x 2.5" x 1.771" x 5"	5" x 2.5" Straight Pod - Two Stops	978-1157-2
5" x 3" x 1.771" x 5"	5" x 3" Straight Pod - Two Stops	834-1157-2
5" x 3.5" x 1.771" x 5"	5" x 3.5" Straight Pod - Two Stops	967-1157-2
5" x 4" x 1.771" x 5"	5" x 4" Straight Pod - Two Stops	836-1157-2
5" x 1.5" x 1.771" x 5"	5" x 1.5" Corner Pod - One Stop	987-1157-1
5" x 1.75" x 1.771" x 6"	5" x 1.75" Corner Pod - One Stop	992-1157-1
5" x 2" x 1.771" x 5"	5" x 2" Corner Pod - One Stop	831-1157-1
5" x 2.5" x 1.771" x 5"	5" x 2.5" Corner Pod - One Stop	979-1157-1
5" x 3" x 1.771" x 5"	5" x 3" Corner Pod - One Stop	833-1157-1
5" x 3.5" x 1.771" x 5"	5" x 3.5" Corner Pod - One Stop	993-1157-1
5" x 4" x 1.771" x 5"	5" x 4" Corner Pod - One Stop	835-1157-1
5" x 1.5" x 1.771" x 5"	5" x 1.5" Corner Pod - Two Stops	987-1157-2
5" x 1.75" x 1.771" x 6"	5" x 1.75" Corner Pod - Two Stops	992-1157-2
5" x 2" x 1.771" x 5"	5" x 2" Corner Pod - Two Stops	831-1157-2
5" x 2.5" x 1.771" x 5"	5" x 2.5" Corner Pod - Two Stops	979-1157-2
5" x 3" x 1.771" x 5"	5" x 3" Corner Pod - Two Stops	833-1157-2
5" x 4" x 1.771" x 5"	5" x 4" Corner Pod - Two Stops	835-1157-2
5" x 5"	5" Replacement Top	Add-3
1/8" x 1/8" x 50'	Replacement Gasket	794

We also make custom pod bases to fit Heian, Weeke, CMS, Anderson, OmniTech and other grid tables!

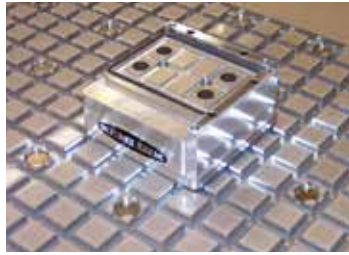

VACUUM SLIDER POD WITH FENCE ONE SIDE OR TWO

Introducing NEMI'S Vacuum Slider Pod with Fence! Now you can locate your smaller parts! This base locates off the grid and sets your fence straight to your grid. These pods come standard with the NEMI Grid base but are available with a variety of bases to fit most ANY grid table.

Size	Description	P/N
4 x 4 Base	4" Slider Pod Fence Base	1142-1
.375 x 4 x 1.66 Tall	4" Slider Pod Fence	1142-2
5 x 5 Base	5" Slider Pod Fence Base	1145-1
.375 x 5 x 1.66 Tall	5" Slider Pod Fence	1145-2

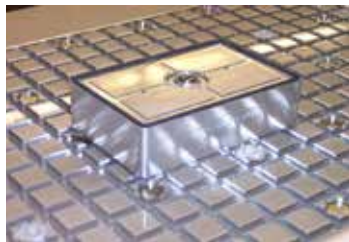

VACUUM POD WITH ROLLER

The NEMI Vacuum Pod with Roller helps you shuttle material onto your machine. Enable vacuum and the roller drops and the vacuum pod grabs your part!

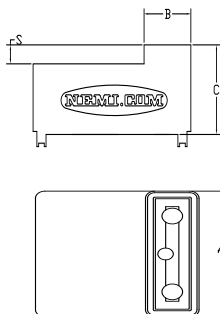

A x B x C	Description	P/N
4" x 4" x 1.771"	4x4 Roller Pod	1040
4" x 6" x 1.771"	4x6 Roller Pod	1036
5" x 5" x 1.771"	5x5 Roller Pod	1144
6" x 6" x 1.771"	6x6 Roller Pod	1043
1/8" x 1/8" x 50'	Replacement Gasket	794



MINI HOLE RUBBER GRIP POD

This Slider Pod features a rubber coated MDF top with multiple holes for holding small parts with ease. Ideal for laser marking!



Base Size (SQR)	Pod Size	Description	P/N
5"	5" x 5"	MDF Gripper Pod	1519

Don't see what you need? Give us a call!

VACUUM WORKHOLDING PRODUCTS TOOLING & ACCESSORIES



GRID COVERS

These Grid Covers help protect the exposed portions of your grid table from excess dirt and damage. They can also make cleanup a breeze! Available in (2) sizes.

Size (L x W)	Description	P/N
5" x 5"	Plastic Grid Cover	1336
10-7/8" x 10-7/8"	Plastic Grid Cover	1557



GRID VACUUM GAUGE

Just place this handy device over any vacuum port on your grid table to check vacuum level! Use for troubleshooting or to monitor vacuum.

Base Size	Description	P/N
4" x 4"	NEMI Grid Vacuum Gauge	1537

See page 14 for available bases.



GRID SEAL PLUG

The NEMI Grid Seal Plug is a basic upgrade to the plugs supplied with your NEMI Grid Table. These plugs are designed for both horizontal and vertical applications and are equipped with an extra O-ring seal for environments where metal chips and thin coolant leakage may be a problem.

Diameter	Height	Description	P/N
.705"	.225"	Grid Seal Plug	1258



SCM ROUTECH GRID PLUGS

If you have an SCM Routech router, NEMI has a huge time saving solution for you! Unlike the plastic OEM plugs shipped with these machines, these plugs are made from steel and can be quickly and easily removed with a magnet!

Head Diameter	Height	Description	P/N
5/8"	.835"	SCM Grid Plug	1282

Don't see what you need? Give us a call!



VACUUM GRID TABLE AUTO VALVE

The Auto Vacuum Valve is available in both the NEMI Grid Tables and in most NEMI Vacuum Pods. These increase your production eliminating the need to remove washers when loading or unloading, changing from vacuum pods to spoil boards or when using flow through. Setups are quick!

Size	Type	Description	P/N
3/4 Dia.	Plastic	Auto Vacuum Valve	1520



VACUUM POD SPIKE INSERTS

The NEMI vacuum pod spikes protrude 1/32" to 1/64" above the top of the pod to help add extra holding power. These are used when only a small surface area to apply vacuum is available. These spikes can be added to most any NEMI vacuum pod top. Pricing includes installation in vacuum pod tops purchased from NEMI.



Description	P/N
Vacuum Pod Spike	697
Spike Adjustment Tool	1275



Maintenance Free!

NOTE: Specifications listed are for our stock rotary unions. Other sizes are available.

VACUUM ROTARY UNIONS

These Vacuum Rotary Unions feature state of the art silicon carbide seals, special sealed-for-life bearings and are completely coolant safe. These unions are ideal for both new and retrofit installations.

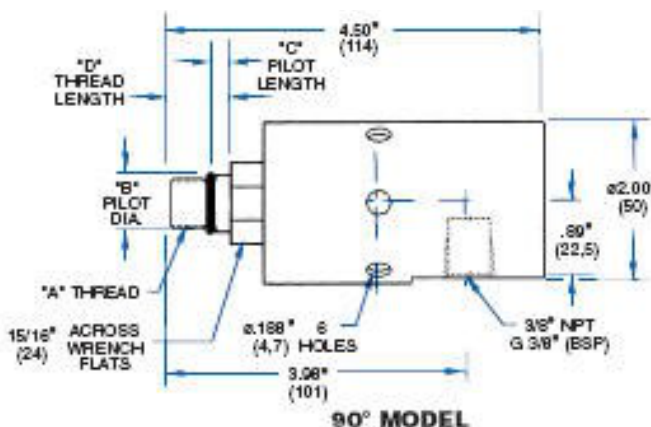

Size	Style	"A"	"B"	"C"	"D"	MAX RPM	P/N
3/8"	90°	5/8-18 UNF LH	.6550-.3555	.188	.75	8500	1591-375

VACUUM WORKHOLDING PRODUCTS

TOOLING & ACCESSORIES



VACUUM POD HOSE

The NEMI vacuum cup hose will not kink like other hoses on the market. Our hose is resistant to chemicals including fuels and oils! Available in four different colors; red, white blue and yellow.

Size	Description	P/N
6MM RED	6MM OD Vacuum Cup Hose - Red	1264
6MM WHITE	6MM OD Vacuum Cup Hose - White	1263
6MM BLUE	6MM OD Vacuum Cup Hose - Blue	1261
6MM YELLOW	6MM OD Vacuum Cup Hose - Yellow	1262
1/4 RED	1/4" OD Vacuum Cup Hose - Red	1265
1/4 WHITE	1/4" OD Vacuum Cup Hose - White	1266
1/4 BLUE	1/4" OD Vacuum Cup Hose - Blue	1267
1/4 YELLOW	1/4" OD Vacuum Cup Hose - Yellow	1268
8MM YELLOW	8MM OD Vacuum Cup Hose -Yellow	1207
8MM RED	8MM OD Vacuum Cup Hose - Red	1172
8MM BLUE	8MM OD Vacuum Cup Hose - Blue	1173
8MM WHITE	8MM OD Vacuum Cup Hose - White	1174
3/8 YELLOW	3/8" OD Vacuum Cup Hose - Yellow	1208
3/8 RED	3/8" OD Vacuum Cup Hose - Red	1175
3/8 BLUE	3/8" OD Vacuum Cup Hose - Blue	1176
3/8 WHITE	3/8" OD Vacuum Cup Hose - White	1177



VACUUM FITTINGS

The replacement vacuum fittings from NEMI feature pre-installed plastic O-rings on the thread for quick, easy installation and a guaranteed seal!

Thread Size	Hose DIA	Description	P/N
1/4" NPT	6mm	6mm Replacement Fitting	1223-6mm
1/4" NPT	1/4"	1/4" Replacement Fitting	1223-250
1/4" NPT	8mm	8mm Replacement Fitting	1223-8mm
1/4" NPT	3/8"	3/8" Replacement Fitting	1223-375



VACUUM GAUGES

NEMI has portable vacuum gages complete with magnetic mounts, fittings and 25 feet of vacuum rated hose for a quick and easy yet portable installation.

Length	Width	Range	Fitting	Description	P/N
3"	2.5"	0-30 hg	1/8" NPT	Vacuum Gauge	1359

VACUUM INTERFACE KITS



The NEMI Vacuum Interface Kit enables you to control individual vacuum zones on your vacuum table without the use of big, bulky manual ball valves. Small toggle switches can be mounted on the operator control panel for quick easy access. This system operates on pneumatics only. No extra electrical connections required. These kits come complete with vacuum hose, manifold, fittings, air valve shutoff & vacuum gauge.

System	Hose I.D.	Description	P/N
Two Zone	2"	Two Zone Vacuum Interface Kit	1502
Four Zone	2"	Four Zone Vacuum Interface Kit	1508



IN LINE VACUUM FILTERS

- Lateral access filters allows easy side servicing and reduced height footprint
- Compact housing designed for sound enclosures and space restricted areas
- Maintenance simplified
- Designed to be used in both inlet pressure and vacuum applications
- "L" style inlet filter: Side inlet tube and bottom outlet port
- Positive sealing side access door
- Vacuum levels to 16"Hg (Non-gas tight)

Description	P/N
Vacuum Inlet Filter	1503



Custom sizes available.

VACUUM POD SETTER

With this setup plate you can do your setups offline while your machine is cutting parts! Simply print your layout and place it beneath our clear acrylic grid plate, shift, rotate and lock your pods and you're ready to go. Now your setups can be made simple with little to no cost.

Size W x L	Type	Description	P/N
8.5" x 11"	Acrylic	Vacuum Pod Setter	739

VACUUM WORKHOLDING PRODUCTS TOOLING & ACCESSORIES



INTEGRATION KITS

Our Integration Kits provide a means of integrating our Grid System to a vacuum pump or system and include all the finest, tested vacuum rated components needed to get your new system up and running quickly.

Description	P/N
3/8" Integration Kit	1363
3/4" Integration Kit	1364
1.0" Integration Kit	1365
1-1/4" Integration Kit	1366
1-1/2" Integration Kit	1049
2.0" Integration Kit	1367
3/8" Manifold Block	1368
3/4" Manifold Block	1369
1.0" Manifold Block	1370
1-1/4" Manifold Block	1371
1-1/2" Manifold Block	1048
2.0" Manifold Block	1372



AUTO VACUUM SHUT OFF VALVE

The Auto Vacuum Shut Off Valve increases your production by eliminating the need to turn off ball valves. What makes this so unique is that electrical wires do not need to be run. Valves are controlled by air only. Available in additional sizes. Call today for a quote!

Size	Type	Description	P/N
1 1/2" NPT	Steel	One Zone Shut Off	1068
1 1/2" NPT	Steel	Two Zone Shut Off	1069

NOTE: Picture shows complete, two zone system. Includes valve and switch only.



VACUUM PRESSURE SWITCH

The NEMI Vacuum Pressure Switch will sense when your vacuum is at a critically low level and unsafe for machining and stop the machine automatically. Switch will be wired to your feed hold relay. This switch kit comes complete with 25 ft. of 5/32" vacuum line, (1) 5/32" T fitting and (1) 5/32 x 1/8 NPT fitting.

Size W x L	Type	Description	P/N
3" x 3" x 3"	Misc	Vacuum Pressure 0-30"	981



TOOL TIGHTENING BLOCK

The NEMI Tool Block gives you easy access to tighten cutting tools and pull studs. Designed to protect your tool holders when tightening tools. Compact design just bolt it to your work bench.

Size	Description	P/N
1" x 9"	Tool Block	801-Taper



COLLET TORQUE WRENCH

This torque wrench was specially designed for setting your torques easily! Simply twist the handle to the desired torque and you're ready to tighten your collets to the required specifications.

Size	Description	P/N
15 1/2" long	Torque Wrench	803
Collet	Collet Key	803-<collet-size>



SPINDLE SOCKET CLEANING TOOL

- Eliminates chatter from poor tool seating.
- Better surface finishes.
- Faster stock removal rates.
- Increases spindle and tool holder life.

Size	Description	P/N
30 Taper	Socket Cleaning Tool	802-30
35 Taper	Socket Cleaning Tool	802-35
40 Taper	Socket Cleaning Tool	802-40
50 Taper	Socket Cleaning Tool	802-50



NEMICOM (PC TO CNC SOFTWARE)

This program can send, receive programs and breakup the file after dumping all programs to your PC. Com ports, Baud rates, Data bits, Stop bits and Parity are all pre-settable. Cable connectors are ready for your cat-5 cable. Run wire and attach our connectors and your ready to send programs to your machine.

Product	Description	P/N
NEMI-COM	Send & Receive Programs	657
Connector	PC TO MACHINE -10ft	713

VACUUM WORKHOLDING PRODUCTS

VACUUM PUMPS // ACCUMULATOR SYSTEMS



COOLANT TRAP/FILTER

The NEMI Coolant Trap/Filter will capture your coolant or dust before it gets to your vacuum pump. Each Water Trap has a bypass so you can empty the container and keep production going.

L x W x H	Type	Description	P/N
8" x 9" x 16"	Misc.	1 1/2 NPT 1 Bank Water Trap/Filter	1565
22" x 6" x 13"	Misc.	1 1/2 NPT 2 Bank Water Trap/Filter	1737



STANDARD VACUUM PUMPS

NEMI now has a vacuum pump for all needs! Just plug into a standard 110 volt plug and your ready to go. These pumps are single stage, Air cooled, Rotary Vane.

L x W x H	Description	P/N
16" x 11" x 9"	110v 15cfm Vacuum Pump	1544
N/A	Vacuum Pump Oil	1487



Model 1255 shown.

NOTE: P/N's 1489, 1490, 1491 ship standard @ 460 volt. Add \$930.00 for 208-230 Volt unit.

CLAW VACUUM PUMPS

NEMI offers a rotary claw-type, positive displacement, dry pump designed for either pressure or vacuum applications. These pumps are available as a single-stage or two-stage vacuum pump. Vacuum or pressure is produced by two non-contacting rotors in an oil-free pumping chamber. The dry, non-contacting design makes them ideal for pneumatic conveying, printing, soil remediation, and any application where dust particles may be present. Wearing parts are separated from the pumping chamber which leads to a longer pump life with low maintenance!

L	W	H	Description	P/N
38-11/16"	16-9/16"	16-1/4"	Vacuum Pump 43CFM 28 Inch	1225
65"	34"	46"	Vacuum Pump Rotary Screw 10 HP 196 acfm 29.9 Hgv	1489
65"	34"	46"	Vacuum Pump Rotary Screw 15 HP 265 acfm 29.9 Hgv	1490
78"	48"	58.5"	Vacuum Pump Rotary Screw 25 HP 371 acfm 29.9 Hgv	1491



Model 1442 shown.



Model 1389 shown.

VACUUM ACCUMULATOR SYSTEMS

These Vacuum Accumulators are a great vacuum pump solution for our portable grid systems as well as being ideal for those working conditions that involve warped or porous materials. The tank retains and pressurizes vacuum in much the same way an air compressor compresses air. A much greater initial 'blast' of vacuum essentially sucks the warp right out of the material. For those conditions where thin coolant leakage can be a problem, the unit is configured with a 2 stage coolant filter to keep moisture out of the pump.

Pump	Capacity	Description	P/N
110v 15cfm, 29.8 hg	30 US Gal	30 Gal Vacuum Accumulator System	1389
208v/460v 43cfm, 28hg	60 US Gal	60 Gal Vacuum Accumulator System	1442
M/N 1389	N/A	Vacuum Pump Oil	1487
N/A	N/A	Wheel Kit	Add-wk

Need a different pump/tank capacity? Give us a call!



Model 1443 shown.



Model 1278 shown.

VACUUM GENERATORS

The NEMI Vacuum Generators are a low cost alternative to conventional vacuum pumps. These units can produce vacuum using compressed air! These units make an excellent companion to our vacuum grid chucks and are equipped with magnetic mounts for quick setup. Additional vacuum cartridges are available for model 1443 & 1509 increasing the CFM by 11.9 with each cartridge added.

L	W	H	Description	P/N
10"	3.5"	5"	4.03 SCFM Vacuum Generator (25hg)	1278
8"	9"	16"	23.7 SCFM Vacuum Generator 1-Bank (27hg)	1443
19"	9"	16"	23.7 SCFM Vacuum Generator 3-Bank (27hg)	1509
N/A	N/A	N/A	11.9 CFM Vacuum Cartridge Upgrade	1486

NOTE: Model 1278 requires 3.39 SCFM of compressed air. Models 1443 & 1509 require 8.48 SCFM of compressed air.

Don't see what you need? Give us a call!

VACUUM WORKHOLDING PRODUCTS

TOOL SETTERS



TOOL SETTER

The NEMI Tool Setter allows you to measure tools off-line. You can measure tools in seconds and be ready for the next job while the machine is still in production. Tool Setter eliminates expensive downtime and costly machine damage which can occur while setting tools. Instead of the intensive bending and stretching of the operator, and the starting and stopping of your CNC machine, the operator pre-sets tools at their work bench. The NEMI Tool Setter allows you to find the distance from the gage line of the holder to the tip of the cutting tool. This number becomes the tool offset number that gets entered into your CNC machine. To help organize the machining center, the Tool Setter is small in size and uses very little work bench space. See our online video demonstration at <http://nemi.com> !

Max Tool Diameter	Max Tool Length	Description	P/N
6"	12"	30 Taper Tool Setter	727-30
6"	12"	40 Taper Tool Setter	727-40
6"	12"	40 Taper Tool Setter—Hard Pocket	727-40H
6"	12"	50 Taper Tool Setter	727-50
6"	12"	50 Taper Tool Setter—Hard Pocket	727-50H
6"	12"	HSK32 Tool Setter	727-HSK32
6"	12"	HSK40 Tool Setter	727-HSK40
6"	12"	HSK63 Tool Setter	727-HSK63
6"	12"	HSK 80 Tool Setter	727-HSK80
6"	12"	HSK100 Tool Setter	727-HSK100
6"	16"	Tool Setter 16" Post	727-16
6"	12"	Tool Setter Metric Post	Add -M
6"	N/A	Pocket, Includes 30T, 40T, HSK32, HSK40, HSK50, HSK63	727-<TAPER>-PS
6"	N/A	Hard Pocket, Includes 30T, 40T, HSK32, HSK40, HSK50, HSK63	727-<TAPER>-PSH
6"	N/A	Pocket, Includes 50T, HSK80, HSK100	727-<TAPER>-PL
6"	N/A	Hard Pocket, Includes 50T, HSK80, HSK100	727-<TAPER>-PLH
N/A	N/A	Indicator Replacement	727-IND

Don't see what you need? Give us a call!

TOOL SETTER PIVOT ARM

Do you have a machine with a Tool Setter probe taking up valuable real estate on your machining table? This unique product from NEMI is for you. When not in use, the Tool Setter Pivot Arm remains retracted and out of the way of the machining table (figure "A"). When in use, the Tool Setter Pivot Arm is extended out over the machining table (figure "B"). The unit is controlled via control box conveniently mounted on the operators control panel (figure "C").

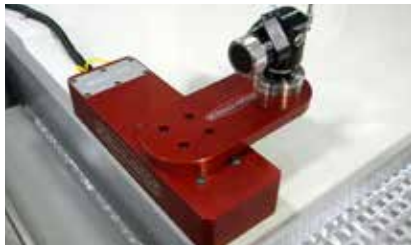

Figure A

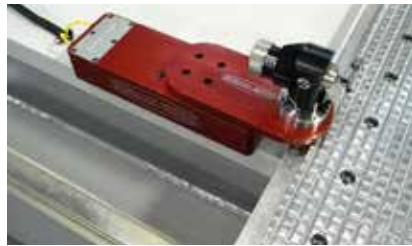
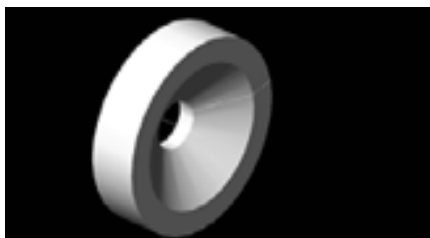

Figure B



Figure C

Size (Retracted)	Size (Extended)	Height	Description	P/N
12" x 11"	17" x 4"	6-3/4"	Toolsetter Pivot Arm	1206



COUNTERSINK GAUGE

Using this countersink gauge you can touch off your tools and always make sure your countersinks are the correct diameter. This specially designed gauge does not use the blunt end or web thickness of your countersinks, it uses a theoretical sharp point.

Description	P/N
Countersink Setting Gauge	666

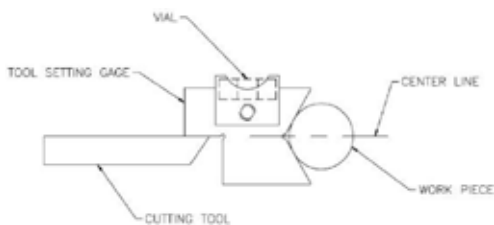

TOOL SETTING GAUGE

The NEMI Tool Setting Gauge accurately sets turning, boring and facing tools on the centerline of the work piece. This tool can also be used to set up grinding wheels on centerline of tool rest for cutter grinding and/or setting table stops on horizontal mills. Index hex, squares, etc., shapes on milling machines. All edges of the Tool Setting Gauge are accurately machined and may be used for vial calibration to suit your intended use. The Vial may be positioned on either side of the body for easier use in different applications. The level of the machine is NOT important as the Tool Setting Gauge is calibrated from the machine at the time of use.

Description	P/N
Tool Setting Gauge	1193

VACUUM WORKHOLDING PRODUCTS

GASKETING



CLOSED CELL GASKETING

Closed Cell Vacuum Gasketing for vacuum fixtures, vacuum pods, spoil boards and grid tables.



Size	Description	Adhesive	P/N	Sale Unit
3/16" Dia	3/16" Round In-Groove	NONE	1510	100' Roll
3/16" Dia	3/16" Round In-Groove	NONE	1649	50' Roll



Size	Description	Adhesive	P/N	Sale Unit
1/4" Dia	1/4" Round In-Groove	NONE	796	250' Roll



Size	Description	Adhesive	P/N	Sale Unit
5/16" Dia	5/16" Round In-Groove	NONE	795	100' Roll



Self adhesive.

Size	Description	Adhesive	P/N	Sale Unit
1/8" x 1/8"	NEMI Pod Gasket	1 Side	794	50' Roll



Self adhesive.

Size	Description	Adhesive	P/N	Sale Unit
1/32" x 1/4"	In Board Gasket	1 Side	791	196' Roll



Self adhesive.

Size	Description	Adhesive	P/N	Sale Unit
1/16" x 1/4"	On Board Gasket	1 Side	790	100' Roll



Self adhesive.

Size	Description	Adhesive	P/N	Sale Unit
1/8" x 1/4"	On Board Gasket	1 Side	789	50' Roll
1/8" x 1/4"	Medium Density In Board Gasket	None	1733	50' Roll



Self adhesive.

Size	Description	Adhesive	P/N	Sale Unit
1/4" x 1/4"	On Board Gasket	1 Side	788	39' Roll
1/4" x 1/4"	Medium Density In Board Gasket	None	1734	75' Roll

VACUUM WORKHOLDING PRODUCTS GASKETING

Self adhesive.



Size	Description	Adhesive	P/N	Sale Unit
1/8" x 3/16"	On Board Gasket	1 Side	1339	50' Roll



Size	Description	Adhesive	P/N	Sale Unit
1/4" x 3/8"	Grid Gasket	NONE	1735	75" Roll



Size	Description	Adhesive	P/N	Sale Unit
1/4" x 5/16"	Grid Gasket	NONE	793	Per FT.



Size	Description	Adhesive	P/N	Sale Unit
1/8" x 5/16"	Grid Gasket	NONE	792	PER FT



Size	Description	Adhesive	P/N	Sale Unit
1/4"w x 5/16"h	"D" Shape Grid Gasket	NONE	1285	PER FT

Self adhesive.



Size	Description	Adhesive	P/N	Sale Unit
3/8"w x 7/16"h	"D" Stone Pod Gasket	1 Side	1115	PER FT

Self adhesive.



Size	Description	Adhesive	P/N	Sale Unit
1/8" x 9/32"	On Board Gasket	1 Side	1573	Per FT.

Self adhesive.



Size	Description	Adhesive	P/N	Sale Unit
1/2" DIA x .062"	Friction Button	1 Side	1281	EA

Self adhesive.



Size	Description	Adhesive	P/N	Sale Unit
1/2" DIA x .03"	Friction Button	1 Side	1542	EA



Size	Description	Adhesive	P/N	Sale Unit
1/2" DIA x .03"	Friction Button	None	1563	EA

TABLE OF CONTENTS

FLAT PLATE FIXTURING



SQUARE VACUUM PODS

The NEMI Square Vacuum Pods are the ideal OEM replacements for Breton, Park, InterMac, and most any other machine. The unique Cross Hatch friction pads provide maximum vacuum flow throughout the entire surface rather than just one or two channels thereby utilizing both maximum vacuum and friction!

Top Size	Base Size	Height	Description	P/N
4" x 4"	4" x 4"	3.5" (89mm)	4 x 4 Vacuum Pod	1716-89
4" x 4"	4" x 4"	3.54" (90mm)	4 x 4 Vacuum Pod	1716-90
4" x 4"	4" x 4"	4.13" (105mm)	4 x 4 Vacuum Pod	1716-105
5" x 5"	5" x 5"	3.5" (89mm)	5 x 5 Vacuum Pod	1134-89
5" x 5"	5" x 5"	3.54" (90mm)	5 x 5 Vacuum Pod	1134-90
5" x 5"	5" x 5"	4.13" (105mm)	5 x 5 Vacuum Pod	1134-105
6" x 6"	6" x 6"	3.5" (89mm)	6 x 6 Vacuum Pod	1130-89
6" x 6"	6" x 6"	3.54" (90mm)	6 x 6 Vacuum Pod	1130-90
6" x 6"	6" x 6"	4.13" (105mm)	6 x 6 Vacuum Pod	1130-105
8" x 8"	8" x 8"	3.5" (89mm)	8 x 8 Vacuum Pod	1133-89
8" x 8"	8" x 8"	3.54" (90mm)	8 x 8 Vacuum Pod	1133-90
8" x 8"	8" x 8"	4.13" (105mm)	8 x 8 Vacuum Pod	1133-105
12" x 12"	12" x 12"	3.5" (89mm)	12x12 Vacuum Pod	1722-89
12" x 12"	12" x 12"	3.54" (90mm)	12x12 Vacuum Pod	1722-90
12" x 12"	12" x 12"	4.13" (105mm)	12x12 Vacuum Pod	1722-105
ALL	ALL	106mm - 150mm	ALL PODS	ALL
ALL	ALL	151mm - 200mm	ALL PODS	ALL



ROUND VACUUM PODS

The NEMI Round Vacuum Pods are the ideal OEM replacements for Breton, Park, InterMac, and most any other machine. The unique Cross Hatch friction pads provide maximum vacuum flow throughout the entire surface rather than just one or two channels thereby utilizing both maximum vacuum and friction! Add "-T" to part number for strap clamp base. Pods ship with 8mm fittings unless otherwise specified.

Top Size	Base Size	Height	Description	P/N
6"	6"	3.5" (89mm)	6" Round Pod	1126-89
6"	6"	3.54" (90mm)	6" Round Pod	1126-90
6"	6"	4.13" (105mm)	6" Round Pod	1126-105
8"	8"	3.5" (89mm)	8" Round Pod	1127-89
8"	8"	3.54" (90mm)	8" Round Pod	1127-90
8"	8"	4.13" (105mm)	8" Round Pod	1127-105
10"	10"	3.5" (89mm)	10" Round Pod	1132-89
10"	10"	3.54" (90mm)	10" Round Pod	1132-90
10"	10"	4.13" (105mm)	10" Round Pod	1132-105
ALL	ALL	106mm-150mm	ALL PODS	ALL
ALL	ALL	151mm - 200mm	ALL PODS	ALL
N/A	N/A	7/16"	Replacement Gasket	1115

All pods are equipped with industry standard 8mm fittings unless otherwise specified Add "-T" to part number for strap clamp base.



Custom sizes Available!

RECTANGULAR VACUUM PODS

The NEMI Rectangular Vacuum Pods are the ideal OEM replacements for Breton, Park, InterMac, and most any other machine. The unique Cross Hatch friction pads provide maximum vacuum flow throughout the entire surface rather than just one or two channels thereby utilizing both maximum vacuum and friction! These pods feature quick change tops and bases for easy replacement of damaged parts. Add "-T" to part number for strap clamp base. Pods ship with 8mm fittings unless otherwise specified.

Size	Height	Description	P/N
3" x 12"	3.5" (89mm)	3" x 12" Modular Vacuum Pod	1128-89
3" x 12"	3.54" (90mm)	3" x 12" Modular Vacuum Pod	1128-90
3" x 12"	4.13" (105mm)	3" x 12" Modular Vacuum Pod	1128-105
6" x 12"	3.5" (89mm)	6" x 12" Modular Vacuum Pod	1129-89
6" x 12"	3.54" (90mm)	6" x 12" Modular Vacuum Pod	1129-90
6" x 12"	4.13" (105mm)	6" x 12" Modular Vacuum Pod	1129-105
8" x 16"	3.5" (89mm)	8" x 16" Modular Vacuum Pod	1238-89
8" x 16"	3.54" (90mm)	8" x 16" Modular Vacuum Pod	1238-90
8" x 16"	4.13" (105mm)	8" x 16" Modular Vacuum Pod	1238-105
10" x 20"	3.5" (89mm)	10" x 20" Modular Vacuum Pod	1237-89
10" x 20"	3.54" (90mm)	10" x 20" Modular Vacuum Pod	1237-90
10" x 20"	4.13" (105mm)	10" x 20" Modular Vacuum Pod	1237-105
ALL	106mm - 150mm	ALL RECTANGULAR PODS	ALL
ALL	151mm - 200mm	ALL RECTANGULAR PODS	ALL
N/A	N/A	Replacement Gasket	1115



SINK SUPPORT POD

The NEMI Sink Support Vacuum Pod provides proven superior support and holding power for narrow areas such as sink cutouts. As with all NEMI pods, the modular design allows for quick replacement or exchange of all components. Use these pods as OEM replacements on Park, Breton, InterMac and many other machines. All pods are equipped with industry standard 8mm fittings unless otherwise specified. Add "-T" to part number for strap clamp base.

Top Size	Base Size	Height	Description	P/N
1.5" x 12"	6" x 12"	3.5" (89mm)	Sink Support Pod	894-89
1.5" x 12"	6" x 12"	3.54" (90mm)	Sink Support Pod	894-90
1.5" x 12"	6" x 12"	4.13" (105mm)	Sink Support Pod	894-105
1.5" x 12"	6" x 12"	106mm - 150mm	Sink Support Pod	894-(mm)
1.5" x 12"	6" x 12"	151mm - 200mm	Sink Support Pod	894-(mm)

VACUUM WORKHOLDING PRODUCTS

FLAT PLATE FIXTURING



CORNER RADIUS PODS

NEMI custom manufactures most any shape and/or size pod or tops for your existing pods, with custom vacuum fixtures to make once difficult jobs a breeze!

W x L x R	Base Size	Height	Description	P/N
6" x 6" x 1.5" R	6" x 6"	3.5" (89mm)	Corner Radius Pod	1736-89
6" x 6" x 1.5" R	6" x 6"	3.54" (90mm)	Corner Radius Pod	1736-90
6" x 6" x 1.5" R	6" x 6"	4.13" (105mm)	Corner Radius Pod	1736-105
6" x 6" x 4.5" R	6" x 6"	3.5" (89mm)	Corner Radius Pod	1277-89
6" x 6" x 4.5" R	6" x 6"	3.54" (90mm)	Corner Radius Pod	1277-90
6" x 6" x 4.5" R	6" x 6"	4.13" (105mm)	Corner Radius Pod	1277-105
6" x 6" x 4.5" R	6" x 6"	106mm - 150mm	Corner Radius Pod	1277-(mm)
6" x 6" x 4.5" R	6" x 6"	151mm - 200mm	Corner Radius Pod	1277-(mm)
8" x 8" x 6.5" R	8" x 8"	3.5" (89mm)	Corner Radius Pod	1274-89
8" x 8" x 6.5" R	8" x 8"	3.54" (90mm)	Corner Radius Pod	1274-90
8" x 8" x 6.5" R	8" x 8"	4.13" (105mm)	Corner Radius Pod	1274-105
8" x 8" x 6.5" R	8" x 8"	106mm - 150mm	Corner Radius Pod	1274-(mm)
8" x 8" x 6.5" R	8" x 8"	151mm - 200mm	Corner Radius Pod	1274-(mm)



MECHANICAL VACUUM SUPPORT CLAMP

The NEMI Vacuum Support Clamp is the perfect clamping solution for those narrow, fragile areas where you need added stability. This mechanical vacuum clamp features a rigid stainless steel and aluminum construction for consistent, rock-solid, clamping and long life. These units have a clamping range of 0" - 1.6" and a gage depth of 1.25" along with a jaw width of 2.5". All pods are equipped with industry standard 8mm fittings unless otherwise specified.



NOTE: Add "-T" to part number for T-Slot table base.

Base Size	Height	Description	P/N
6" x 6"	3.5" (89mm)	Vacuum Support Clamp	1236-89-6
6" x 6"	3.54" (90mm)	Vacuum Support Clamp	1236-90-6
6" x 6"	4.13" (105mm)	Vacuum Support Clamp	1236-105-6
8" x 8"	3.5" (89mm)	Vacuum Support Clamp	1236-89-8
8" x 8"	3.54" (90mm)	Vacuum Support Clamp	1236-90-8
8" x 8"	4.13" (105mm)	Vacuum Support Clamp	1236-105-8
6" x 12"	3.5" (89mm)	Dual Vacuum Support Clamp	1236-89-D
6" x 12"	3.54" (90mm)	Dual Vacuum Support Clamp	1236-90-D
6" x 12"	4.13" (105mm)	Dual Vacuum Support Clamp	1236-105-D
ALL	106mm-150mm	ALL CLAMPS	ALL
ALL	151mm - 200mm	ALL CLAMPS	ALL



VACUUM POD FENCE

The NEMI Vacuum Pod Fence is the ideal OEM replacement for Breton, Park, Intermac, Komo and most any other machine. NEMI's Vacuum Pod with Fence allows for simplified part location. This product combines speed of set up and maximum vacuum flow-through. Add "-T" to part number for strap clamp base. Pods ship with 8mm fittings unless otherwise specified.

Base Size	Height	Description	P/N
6" x 10.25"	127 mm	Vacuum Pod Fence	892



VACUUM PIN STOP

The NEMI Vacuum Pin Stop is designed for quick and easy material location. Simply locate material against the delrin pins, pull the pins and you're ready to run! Equipped with industry standard 8mm fitting unless otherwise specified.

Pin Dia	Base Dia	Overall Height	Description	P/N
1.5" (38mm)	6" (152.5mm)	6" (152.5mm)	Pin Stop	1183
1.5" (38mm)	N/A	5.25" (133.3mm)	Replacement Pin	1183-2



PORTABLE VACUUM MANIFOLDS

The NEMI Vacuum Manifold is compact and uses minimal space on your machine table. These units are available with individual ball valves for each port or (1) Bleed-to-Atmosphere slider valve providing instant vacuum application and release on all ports. Ball valves can be upgraded to Bleed-to-Atmosphere Slider Valves. Features include rubber feet and a carry handle.

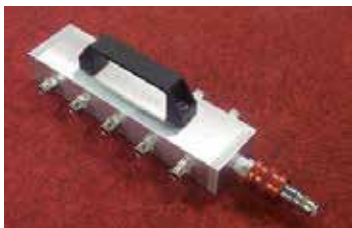

Size W x L x H	Description	P/N
9" x 10" x 3-1/2"	10 Port Ball Valve Manifold	1194-10
9" x 20" x 3-1/2"	20 Port Ball Valve Manifold	1194-20
3" x 4" x 3"	2-Zone Manifold with expandible 2-12 port outlet	1730
9" x 10" x 3-1/2"	10 Port Manifold - (1) Slider Valve	1345-10
9" x 20" x 3-1/2"	20 Port Manifold - (1) Slider Valve	1345-20

Don't see what you need? Give us a call!



STRAP CLAMPS FOR T-SLOT TABLE MACHINES

NEMI Strap Clamps have been designed to hold your vacuum pods firmly in place on a T-Slot table, such as on some Breton Machines. Special sizes are available upon request.

Size	Description	P/N
2" x 4.75"	T-Slot Table Strap Clamp (Breton Replacement)	1135
2" x 8"	T-Slot Table Strap Clamp (Breton Replacement)	1136



FLAT TABLE VACUUM PACKAGE

The NEMI Flat Table Vacuum Package comes with a variety of vacuum pods, a 10 port vacuum manifold and 50 ft of our vacuum hose.

Item	Qty	Description	P/N
4" x 4" Vacuum Pod	8	One PC Flat Plate Pod	1247
4" x 2" Vacuum Pod	2	One PC Flat Plate Pod	1260
Vacuum Hose	50'	1/4" OD Vacuum Cup Hose	1265
Manifold	1	10 Port Vacuum Manifold	1194-10
N/A	1	Flat Table Vacuum Package	1288

NOTE: Vacuum pump sold separately.



FLAT TABLE ONE PIECE VACUUM POD

NEMI now offers a low cost One Piece Vacuum Pod for flat table applications. These vacuum pods feature the same configuration as our standard slider pod top on both the top and bottom.

Pod Size	Height	Description	P/N
4" x 4"	1.416"	One PC Flat Plate Pod	1247
4" x 2"	1.416"	One PC Flat Plate Pod	1260

NOTE: 1/4" vacuum hose sold separately.



Don't see what you need? Give us a call!

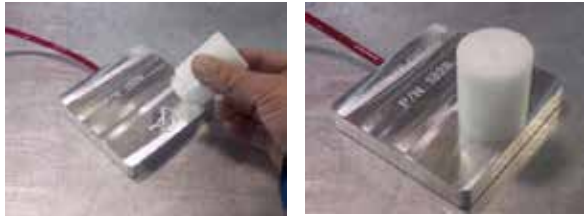

FLAT TABLE LOCATOR PIN POD

The NEMI Flat Table Locator Pin Pod features a removable locator pin so you can easily machine the parameter of your workpiece.

Size L x W x H	Description	P/N
4" x 4" x 2.5"	Flat Table Locator Pin	1328



FLAT PLATE VACUUM POD BASE

NEMI now offers the best of two worlds! This pod base features the flexibility of flat plate pod location & placement while maintaining the versatility of interchangeable tops offered on our standard Slider Pods. These pods can be configured for individual use as well as daisy chaining. Pods ship with 8mm fittings unless otherwise specified. *NOTE: Tops not included.

Base Size	Base Height	Description	P/N
4" x 4"	.708"	Flat Plate Vacuum Pod Base	1239
5" x 5"	.708"	Flat Plate Vacuum Pod Base	1240



LOW PROFILE VACUUM PODS

NEMI's part holding solution for CMM machines! 2" vacuum pods can be stacked to achieve desired heights. Precision machined to +/- .0005".

A	B	C	D	Description	P/N
1.98"	.24"	1.5"	2.47"	2" Stackable CMM Pod	1189
1.24"	.57"	1.5"	2.47"	1-1/4" CMM Pod	1197

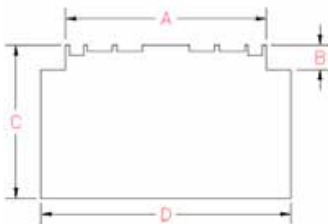

Custom sizes Available!



BENCH VACUUM PODS

NEMI now has a solution for the hobbyist working at home or in a factory! NEMI has a low cost solution for holding parts securely for manual bench operations. Vacuum hose and pumps sold separately.

Size Dia x H	Description	P/N
5-1/2" x 3-3/8" x 1.0"	Table Pod	853



RAPID CAPTURE GEOMETRY WITH THE NEMI DIGICODER

The NEMI DigiCoder™ is the complete solution for your digital templating needs! The wide range of command options accommodate a variety of templating methods. You can digitize this basic template by simply picking two points on each side. The machine then draws the template for you automatically.

Arcs are produced by simply picking the start, mid and endpoints of the arc. For more complex shapes such as scribed walls you can use the exclusive TRACE function, which does just that. Simply follow the desired shape with the probe. The NEMI DigiCoder is the result of more than 20 years experience in DigiCoder manufacturing!

Positioning Accuracy: x, Y, +/- .01. Software included outputs G-Code, Script file, x,Y, raw Data and DxF file.

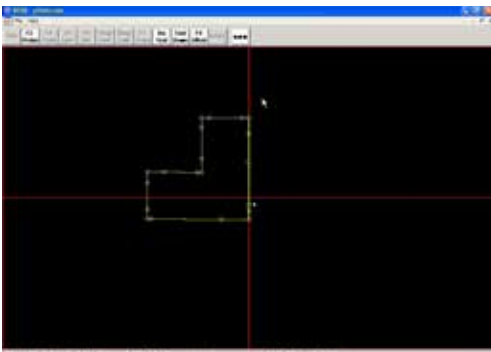

SETTING UP FOR DIGITIZING

- Place your part on the digitizer and attach to back board of digitizer.
- Start the NEMI digitizer software.
- Go to file start
- Pick your point for part zero or align using 3 points.
- Move probe to your start point of digitizing.
- Pick the Tool down icon.
- Pick the trace icon.
- Trace around your part with the probe.
- Exit software and save file.



RAPID CAPTURE YOUR GEOMETRY WITH OUR 2 AXIS DIGITIZER

DigiCoder™ is a 2 digitizer for reverse engineering your parts, patterns or templates which you would like to see reproduced without the time consuming procedures of point to point digitizing. DigiCoder™, in combination with a personal computer, allows you to trace parts and patterns with a probe and automatically generate the geometry for that form. The algorithms which generate the geometry reflect true lines and arcs. DigiCoder™ introduces ease and simplicity to your CNC operations.

Positioning Accuracy: x, Y, +/- .01. Software included outputs G-Code, Script file, x,Y, raw Data and DxF file.



x Axis Y Axis	Description	P/N
144 x 72	2-Axis DIGICODER	1178-2D



DIGITIZER RETRO-FIT KIT

Now you can retro-fit your drafting table, drafting boards, Skalar, Safco, Vemco and many others! The NEMI retro fit kit easily mounts to your existing backboard so you can be up and digitizing in minutes! Drafting board NOT included.

Positioning Accuracy: : x, Y, +/- .01 Software included outputs G-Code, Script.

Special Sizes Available Upon Request.

x Axis Y Axis	Description	P/N
4' x 8'	2-Axis DIGICODER	1196-96x48-2D
5' x 12'	2-Axis DIGICODER	1196-144x60-2D

DIGITIZER COMPUTER UPGRADE KIT

Breathe new life into your NEMI Digitizer with this tablet PC upgrade kit! This kit adds new features like wireless Ethernet, on machine DxF processing and more. Pre-loaded with the latest NEMI-DIGI software, this kit has the mounting hardware and everything needed to be up and running in no time!

Description	P/N
Digitizer Tablet PC Upgrade Kit	1440

MORE PRODUCTS COMING SOON!

Don't see what you're looking for? Give us a call today!

We have over 30 years of experience manufacturing and designing custom fixtures. We can work with you to build from your drawings or design a complete solution. Call us for a quote or for all your custom vacuum workholding needs.

Reminder - ordering is fast and simple! See below for details.

ORDERING

- Phone Toll-Free 888-625-5367 or (763-856-2044).
- Monday through Friday 8:00 a.m. to 4:30 p.m. Central time zone.
- Fax your Purchase Order to 763-856-3378, 24 hours a day.
- Email your purchase order to office@nemi.com.

INTERNATIONAL SHIPPING OUTSIDE U.S.

- We ship worldwide.
- Product prices and delivery may change when shipping outside the U.S.
- Purchaser is responsible for paying any duties and taxes.

SHIPPING

- We ship UPS, United Postal Service and many national trucking companies.
- Our shipping department will ensure your order is transported in the most economical manner possible

RUSH ORDERS

- Your order can be shipped Next day or Second day.
- Orders requesting Rush Shipping may have an additional cost.

PAYMENT

- Payment by Check - Make checks payable to: Northern Engineering & Mfg. Inc.
- C.O.D.
- Major Credit Cards accepted: VISA, AMERICAN EXPRESS, MASTERCARD, and DISCOVER
- Open Account- Request a credit application by emailing Office@NEMI.com

TERMS & CONDITIONS

- By placing an order and not stating otherwise, buyer has read and agreed to all Terms & Conditions set forth by Northern Engineering & Mfg. Inc.
- See pages 6-7 for Terms & Conditions.
- We make every effort to maintain our pricing, however, due to market fluctuations, prices are subject to change without prior notice.

NEMI.COM

11841 243rd Ave NW
Zimmerman, MN 55398
Phone: 763-856-2044
www.nemi.com

Version 14